



U.S. Department of Transportation  
Federal Highway Administration

## Errata

**Date:** October 22, 2013

**Issuing Office:** Federal Highway Administration—Office of Research, Development, and Technology: Infrastructure Research and Development

**Address:** Turner-Fairbank Highway Research Center, 6300 Georgetown Pike, McLean, VA 22101

**Name of Document:** **Guidelines for Sampling, Assessing, and Restoring Defective Grout in Prestressed Concrete Bridge Post-Tensioning Ducts**

**FHWA Publication No.:** **FHWA-HRT-13-028**

The following changes were made to the document after publication:

Location	Incorrect Values	Corrected Values
Table 32 on page 90	CD3 $0.08 < \text{Cl}^- \leq 0.20^b$	CD3 $0.2 < \text{Cl}^- \leq 0.50^b$
Table 33 on page 91	CD3 $0.02 < \text{Cl}^- \leq 0.50$	CD3 $0.2 < \text{Cl}^- \leq 0.50$

# Guidelines for Sampling, Assessing, and Restoring Defective Grout in Prestressed Concrete Bridge Post-Tensioning Ducts

PUBLICATION NO. FHWA-HRT-13-028

OCTOBER 2013



U.S. Department of Transportation  
**Federal Highway Administration**

Research, Development, and Technology  
Turner-Fairbank Highway Research Center  
6300 Georgetown Pike  
McLean, VA 22101-2296

## FOREWORD

Post-tensioned (PT) tendons have been widely utilized in concrete bridges in the United States. The advantages of PT bridges compared to bridges constructed using conventional reinforcement include greater span length, structural efficiency, reduced materials, and a more streamlined appearance. However, PT tendons can be susceptible to corrosion and ultimately failure if physical deficiencies (PDs) or chemical deficiencies (CDs) are present. Examples of PDs include separation, segregation, presence of soft material, and free water, while an example of a CD includes concentrations of chloride that exceed the allowable limit as specified by the American Association of State Highway and Transportation Officials and other specifications. The failure of a few tendons can compromise overall structural integrity.

Inspections of bridge PT tendons have revealed both PDs and CDs as well as strand tendon failures caused by corrosion have been reported. This study was performed to provide bridge owners with a practical protocol for inspecting, sampling, analyzing, evaluating, and responding to bridge grout concerns.

Jorge E. Pagán-Ortiz  
Director, Office of Infrastructure  
Research and Development

### Notice

This document is disseminated under the sponsorship of the U.S. Department of Transportation in the interest of information exchange. The U.S. Government assumes no liability for the use of the information contained in this document. This report does not constitute a standard, specification, or regulation.

The U.S. Government does not endorse products or manufacturers. Trademarks or manufacturers' names appear in this report only because they are considered essential to the objective of the document.

### Quality Assurance Statement

The Federal Highway Administration (FHWA) provides high-quality information to serve Government, industry, and the public in a manner that promotes public understanding. Standards and policies are used to ensure and maximize the quality, objectivity, utility, and integrity of its information. FHWA periodically reviews quality issues and adjusts its programs and processes to ensure continuous quality improvement.

## TECHNICAL REPORT DOCUMENTATION PAGE

1. Report No. FHWA-HRT-13-028	2. Government Accession No.	3. Recipient's Catalog No.	
4. Title and Subtitle Guidelines for Sampling, Assessing, and Restoring Defective Grout in Prestressed Concrete Bridge Post-Tensioning Ducts		5. Report Date October 2013	
		6. Performing Organization Code	
7. Author(s) Teddy S. Theryo, William H. Hartt, and Piotr Paczkowski		8. Performing Organization Report No.	
9. Performing Organization Name and Address Parsons Brinckerhoff, Inc. 2202 North West Shore Blvd. Suite 300 Tampa, FL 33607  William H. Hartt, PhD, PE, F-NACE Consulting Engineer 20914 Morada Court Boca Raton, FL 33433		10. Work Unit No.	
		11. Contract or Grant No.	
12. Sponsoring Agency Name and Address Office of Infrastructure Research and Development Federal Highway Administration 6300 Georgetown Pike McLean, VA 22101-2296		13. Type of Report and Period Covered Final Report	
		14. Sponsoring Agency Code	
15. Supplementary Notes The Contracting Officer's Technical Representatives (COTRs) were Y.P. Virmani and H. Ghasemi, HRDI-60. An expert task group comprised of members from industry, academia, State transportation departments, and the post-tensioning industry provided valuable technical input and guidance. This study was part of the Long-Term Bridge Performance Program.			
16. Abstract A significant proportion of the U.S. bridge inventory is based on bonded post-tensioned (PT) concrete construction. An important aspect of maintaining corrosion protection of these PT systems is assuring that tendon ducts are properly grouted with an acceptable material. Grout is a cementitious material typically used to provide corrosion protection to the strands used in PT concrete bridges. However, inspections have revealed fractured strands and, in some cases, failed tendons as a consequence of corrosion, even with the newer prepackaged, preapproved thixotropic grouts. Studies to-date have attributed this corrosion to physical or chemical grout deficiencies (or both), the former consisting of air voids, free water, and unhardened, segregated, or separated grout and the latter of chloride concentration in excess of what is specified by the American Association of State Highway and Transportation Officials and other specifications. Based on collected information and data analysis, State transportation departments can evaluate if grout deficiencies are present in the tendons of their PT bridges and determine the significance of any deficiencies. Durability concerns associated with PT tendons were raised as early as 1999 when tendon failures were seen in some PT bridges as a result of strand corrosion due to the collection of bleed water in grout voids at tendon profile locations like anchorages and crest areas. While the development of prepackaged thixotropic grout was thought to provide a solution to the bleed water problem, corrosion-caused tendon failures on relatively new PT bridges have occurred, and forensic studies have revealed separation and segregation of grout materials as well as the presence of soft material, free water, and high chloride and sulfate content. <sup>(1-3)</sup> Consequently, it has become important to examine the overall quality of materials and construction for some in-place grouts in existing PT bridges. The purpose of this study is to provide State transportation departments with guidance regarding tendon inspection, grout sampling, data analysis, and interpretation.			
17. Key Words Post-tensioned tendons, Bridges, Corrosion, Grout, Chlorides, Grout defects, Inspection, Sampling		18. Distribution Statement No restrictions. This document is available to the public through the National Technical Information Service, Springfield, VA 22161.	
19. Security Classif. (of this report) Unclassified	20. Security Classif. (of this page) Unclassified	21. No of Pages 130	22. Price

# SI\* (MODERN METRIC) CONVERSION FACTORS

## APPROXIMATE CONVERSIONS TO SI UNITS

Symbol	When You Know	Multiply By	To Find	Symbol
<b>LENGTH</b>				
in	inches	25.4	millimeters	mm
ft	feet	0.305	meters	m
yd	yards	0.914	meters	m
mi	miles	1.61	kilometers	km
<b>AREA</b>				
in <sup>2</sup>	square inches	645.2	square millimeters	mm <sup>2</sup>
ft <sup>2</sup>	square feet	0.093	square meters	m <sup>2</sup>
yd <sup>2</sup>	square yard	0.836	square meters	m <sup>2</sup>
ac	acres	0.405	hectares	ha
mi <sup>2</sup>	square miles	2.59	square kilometers	km <sup>2</sup>
<b>VOLUME</b>				
fl oz	fluid ounces	29.57	milliliters	mL
gal	gallons	3.785	liters	L
ft <sup>3</sup>	cubic feet	0.028	cubic meters	m <sup>3</sup>
yd <sup>3</sup>	cubic yards	0.765	cubic meters	m <sup>3</sup>
NOTE: volumes greater than 1000 L shall be shown in m <sup>3</sup>				
<b>MASS</b>				
oz	ounces	28.35	grams	g
lb	pounds	0.454	kilograms	kg
T	short tons (2000 lb)	0.907	megagrams (or "metric ton")	Mg (or "t")
<b>TEMPERATURE (exact degrees)</b>				
°F	Fahrenheit	5 (F-32)/9 or (F-32)/1.8	Celsius	°C
<b>ILLUMINATION</b>				
fc	foot-candles	10.76	lux	lx
fl	foot-Lamberts	3.426	candela/m <sup>2</sup>	cd/m <sup>2</sup>
<b>FORCE and PRESSURE or STRESS</b>				
lbf	poundforce	4.45	newtons	N
lbf/in <sup>2</sup>	poundforce per square inch	6.89	kilopascals	kPa

## APPROXIMATE CONVERSIONS FROM SI UNITS

Symbol	When You Know	Multiply By	To Find	Symbol
<b>LENGTH</b>				
mm	millimeters	0.039	inches	in
m	meters	3.28	feet	ft
m	meters	1.09	yards	yd
km	kilometers	0.621	miles	mi
<b>AREA</b>				
mm <sup>2</sup>	square millimeters	0.0016	square inches	in <sup>2</sup>
m <sup>2</sup>	square meters	10.764	square feet	ft <sup>2</sup>
m <sup>2</sup>	square meters	1.195	square yards	yd <sup>2</sup>
ha	hectares	2.47	acres	ac
km <sup>2</sup>	square kilometers	0.386	square miles	mi <sup>2</sup>
<b>VOLUME</b>				
mL	milliliters	0.034	fluid ounces	fl oz
L	liters	0.264	gallons	gal
m <sup>3</sup>	cubic meters	35.314	cubic feet	ft <sup>3</sup>
m <sup>3</sup>	cubic meters	1.307	cubic yards	yd <sup>3</sup>
<b>MASS</b>				
g	grams	0.035	ounces	oz
kg	kilograms	2.202	pounds	lb
Mg (or "t")	megagrams (or "metric ton")	1.103	short tons (2000 lb)	T
<b>TEMPERATURE (exact degrees)</b>				
°C	Celsius	1.8C+32	Fahrenheit	°F
<b>ILLUMINATION</b>				
lx	lux	0.0929	foot-candles	fc
cd/m <sup>2</sup>	candela/m <sup>2</sup>	0.2919	foot-Lamberts	fl
<b>FORCE and PRESSURE or STRESS</b>				
N	newtons	0.225	poundforce	lbf
kPa	kilopascals	0.145	poundforce per square inch	lbf/in <sup>2</sup>

\*SI is the symbol for the International System of Units. Appropriate rounding should be made to comply with Section 4 of ASTM E380.  
(Revised March 2003)

## TABLE OF CONTENTS

<b>CHAPTER 1. BACKGROUND.....</b>	<b>1</b>
<b>CHAPTER 2. OBJECTIVES OF INSPECTION .....</b>	<b>3</b>
<b>CHAPTER 3. PT SYSTEMS .....</b>	<b>5</b>
<b>BACKGROUND .....</b>	<b>5</b>
<b>PT TENDON TYPES .....</b>	<b>7</b>
<b>PT BRIDGE TYPES.....</b>	<b>8</b>
Cast-in-Place (CIP) PT Box Girder Bridges on False Works.....	8
CIP PT Concrete Slab and T-Girder Bridges.....	10
CIP Segmental Balanced Cantilever Bridge.....	11
Precast Spliced I-Girder Bridge .....	14
Precast Spliced U-Girder Bridge .....	15
Precast Segmental Balanced Cantilever Bridge.....	17
Precast Segmental Span-by-Span Bridge.....	18
Concrete Cable-Supported Bridge .....	21
Special PT Concrete Substructures.....	22
<b>CHAPTER 4. GROUT DEFICIENCIES .....</b>	<b>25</b>
<b>BACKGROUND .....</b>	<b>25</b>
Cl <sup>-</sup> Threshold.....	25
Previous Investigations.....	27
Deficiencies.....	32
<b>CHAPTER 5. MINIMUM NUMBER OF TEST SAMPLES .....</b>	<b>33</b>
<b>GENERAL.....</b>	<b>33</b>
<b>INSPECTION OPTIONS.....</b>	<b>34</b>
<b>INSPECTING CL<sup>-</sup> CONTENT (OPTION 1) .....</b>	<b>34</b>
Project with Complete Grouting Records.....	34
Project with Incomplete or No Grouting Records .....	35
<b>INSPECTING ALL GROUT DEFICIENCIES (OPTION 2) .....</b>	<b>35</b>
Probability of Defect Indicator .....	37
Consequence of Failure Indicator .....	39
Risk Level.....	41
Acceptable Fraction of Tendons with Undetected Deficient Grout.....	41
Minimum Number of Inspected Tendons .....	41
Sampling Procedure Summary .....	46
<b>EXAMPLES .....</b>	<b>47</b>
Typical Balanced Cantilever Bridge.....	47
Typical Spliced Girder Bridge.....	53
Typical Span-by-Span Segmental Bridge.....	56
Typical PT Bridge with Draped Tendons .....	58

<b>CHAPTER 6. GROUT SAMPLING AND TEST METHODS .....</b>	<b>61</b>
<b>GENERAL CONSIDERATIONS .....</b>	<b>61</b>
Sample Size.....	66
Analyses.....	66
Tools, Equipment, and Instrumentation.....	68
Reporting.....	69
<b>CHAPTER 7. STRATEGIC SAMPLING LOCATIONS.....</b>	<b>73</b>
<b>BACKGROUND .....</b>	<b>73</b>
<b>BALANCED CANTILEVER BRIDGE.....</b>	<b>75</b>
Continuity Tendon (Internal Tendon in the Bottom Flange).....	75
Cantilever Tendon (Internal).....	77
<b>PRECAST SEGMENTAL SPAN-BY-SPAN BRIDGE .....</b>	<b>77</b>
<b>CIP PT BRIDGE.....</b>	<b>78</b>
<b>SPLICED GIRDER BRIDGE .....</b>	<b>78</b>
<b>CHAPTER 8. RESTORATION METHODS.....</b>	<b>81</b>
<b>GENERAL.....</b>	<b>81</b>
<b>TEMPORARY RESTORATION.....</b>	<b>82</b>
External Tendon.....	82
Internal Tendon.....	83
<b>PERMANENT RESTORATION .....</b>	<b>83</b>
External Tendon.....	83
Internal Tendon.....	84
Grout Cap.....	85
<b>RESTORATION MATERIAL .....</b>	<b>87</b>
<b>CHAPTER 9. INTERPRETATION OF RESULTS AND COURSES OF ACTION.....</b>	<b>89</b>
<b>BACKGROUND .....</b>	<b>89</b>
Evaluation Approach and Interpretation.....	89
Examples.....	92
Reinspections, Non-Destructive Testing (NDT), and Monitoring.....	94
<b>APPENDIX A. TYPICAL BALANCED CANTILEVER BRIDGE PLANS .....</b>	<b>97</b>
<b>APPENDIX B. TYPICAL SPLICED GIRDER BRIDGE PLANS .....</b>	<b>109</b>
<b>REFERENCES.....</b>	<b>119</b>

## LIST OF FIGURES

Figure 1. Illustration. Basic PT anchorage system .....	5
Figure 2. Photo. Old generation of PT anchorage system .....	6
Figure 3. Photo. New generation of PT anchorage system.....	6
Figure 4. Illustration. Internal tendon .....	7
Figure 5. Illustration. External tendon .....	7
Figure 6. Photo. External tendons at deviator.....	8
Figure 7. Photo. CIP concrete box girder bridge on false works.....	9
Figure 8. Illustration. CIP bridge typical tendon layout .....	9
Figure 9. Photo. Blister at the top flange .....	10
Figure 10. Illustration. Transverse internal tendon in the diaphragm.....	10
Figure 11. Photo. CIP PT concrete slab bridge.....	11
Figure 12. Illustration. PT slab bridge typical tendon layout .....	11
Figure 13. Photo. CIP segmental balanced cantilever bridge.....	12
Figure 14. Photo. CIP balanced cantilever bridge during construction using form traveler .....	13
Figure 15. Photo. Typical bottom flange blister .....	13
Figure 16. Illustration. Typical vertical tendon in the web.....	14
Figure 17. Illustration. Typical vertical tendon in the diaphragm .....	14
Figure 18. Photo. Precast spliced girder bridge .....	15
Figure 19. Photo. Precast spliced girder bridge during erection.....	15
Figure 20. Photo. Precast spliced U-girder bridge during erection.....	16
Figure 21. Photo. Precast U-girder supported on temporary false work .....	17
Figure 22. Photo. Precast segmental balanced cantilever bridge erection using a segment lifter.....	18
Figure 23. Photo. Precast segmental span-by-span erection using an overhead gantry .....	19
Figure 24. Illustration. Typical precast segmental span-by-span external PT tendon layout .....	20
Figure 25. Photo. Precast segmental cable stayed bridge .....	22
Figure 26. Illustration. Cross section of precast segmental columns.....	23
Figure 27. Photo. PT straddle bent during construction .....	23
Figure 28. Photo. Failed tendon cross section .....	27
Figure 29. Photo. Longitudinal section of a tendon section with types 1–3 grout identified .....	28
Figure 30. Photo. Opened tendon end showing predominantly type 3 grout and strand corrosion products.....	29
Figure 31. Photo. Opened tendon end showing types 3 and 1 grout and strand corrosion products.....	29
Figure 32. Photo. Opened tendon end revealing type 4 grout (bottom half), type 1 grout (center region), and strand corrosion products (upper region) .....	30
Figure 33. Photo. Opened anchorage on the Carbon Plant Road bridge over IH-37.....	30
Figure 34. Equation. Reaction of the ferrous ion with water and sulfate ion to yield ferrous hydroxide and sulfuric acid .....	31
Figure 35. Flowchart. Inspection options .....	34
Figure 36. Flowchart. Grout inspection processes.....	36
Figure 37. Graph. Risk matrix .....	37
Figure 38. Equation. Overall probability of defect indicator.....	39
Figure 39. Equation. Overall consequence of failure indicator .....	40



Figure 40. Equation. Risk .....	41
Figure 41. Equation. Probability mass function for hypergeometric distribution .....	42
Figure 42. Graph. Example of PMF for hypergeometric distribution .....	42
Figure 43. Equation. CDF .....	42
Figure 44. Graph. Example of CDF for a hypergeometric distribution.....	43
Figure 45. Graph. Minimum number of tendons required to detect at least one tendon with deficient grout assuming 5 percent of the samples are defective.....	44
Figure 46. Graph. Minimum number of tendons required to detect at least one tendon with deficient grout assuming 10 percent of the samples are defective.....	45
Figure 47. Graph. Minimum number of tendons required to detect at least one tendon with deficient grout assuming 20 percent of the samples are defective.....	45
Figure 48. Graph. Minimum number of tendons required to detect at least one tendon with deficient grout assuming 30 percent of the samples are defective.....	46
Figure 49. Graph. Balanced cantilever bridge—tendon risk categories .....	48
Figure 50. Graph. Spliced girder bridge—tendon risk categories .....	54
Figure 51. Graph. Span-by-span segmental bridge—tendon risk categories.....	58
Figure 52. Graph. PT bridge—tendon risk categories .....	60
Figure 53. Photo. Dial gauge used to determine the depth of a grout air void .....	61
Figure 54. Photo. Grout sample acquisition at an opened internal tendon end cap by light chipping.....	62
Figure 55. Photo. Concrete excavation to expose an internal tendon .....	63
Figure 56. Photo. Internal tendon access at an intermediate location by drilling.....	64
Figure 57. Photo. Access hole in an internal tendon at an intermediate location revealing strand and grout.....	64
Figure 58. Photo. View of a duct interior revealing a channel air void.....	65
Figure 59. Illustration. Bridge representation used to identify grout sampling locations.....	69
Figure 60. Illustration. Chart used to record the location and information for individual grout samples .....	70
Figure 61. Illustration. Chart used to record and present analysis results for individual grout samples .....	71
Figure 62. Photo. Removing a permanent grout cap .....	73
Figure 63. Photo. Exposed anchor head after grout sampling .....	74
Figure 64. Photo. Locating internal tendons in the web wall using GPR.....	75
Figure 65. Photo. Partial removal of a grout cap .....	76
Figure 66. Illustration. Typical cantilever tendon inspection point locations.....	76
Figure 67. Illustration. Typical continuity tendon inspection point locations .....	77
Figure 68. Illustration. Typical span-by-span bridge external tendon inspection point locations .....	78
Figure 69. Illustration. CIP PT bridge inspection point locations .....	78
Figure 70. Illustration. Spliced bulb-tee girder bridge inspection point locations.....	79
Figure 71. Photo. Spliced bulb-tee girder bridge CIP joint detail .....	79
Figure 72. Illustration. Spliced U-girder bridge inspection locations.....	80
Figure 73. Photo. Temporary restoration of an external tendon .....	82
Figure 74. Photo. Permanent restoration of an external tendon using heat shrink sleeve .....	83
Figure 75. Illustration. Permanent restoration of an internal tendon duct .....	84
Figure 76. Photo. Completed restoration of a partially cut grout cap prior to coating .....	85

Figure 77. Photo. Applying elastomeric coating over a grout cap.....	86
Figure 78. Photo. Completed permanent restoration of a grout cap .....	86
Figure 79. Flowchart. Inspection, sampling, evaluation, and actions for levels 1 and 2 inspections for option 1.....	92
Figure 80. Flowchart. Inspection, sampling, evaluation, and actions for levels 1 and 2 inspections for option 2.....	92
Figure 81. Illustration. Segment layout—part 1 .....	97
Figure 82. Illustration. Segment layout—part 2 .....	98
Figure 83. Illustration. Bulkhead details.....	99
Figure 84. Illustration. Longitudinal PT layout—part 1 .....	100
Figure 85. Illustration. Longitudinal PT layout—part 2 .....	101
Figure 86. Illustration. Longitudinal PT layout—part 3 .....	102
Figure 87. Illustration. Longitudinal PT layout—part 4 .....	103
Figure 88. Illustration. Longitudinal PT layout—part 5 .....	104
Figure 89. Illustration. Longitudinal PT layout—part 6 .....	105
Figure 90. Illustration. Longitudinal PT layout—part 7 .....	106
Figure 91. Illustration. Longitudinal PT layout—part 8 .....	107
Figure 92. Illustration. Plan and elevation—main channel unit .....	109
Figure 93. Illustration. Bridge section .....	110
Figure 94. Illustration. Pier cap PT details .....	111
Figure 95. Illustration. Tendon profile—main channel unit.....	112
Figure 96. Illustration. Modified Florida bulb-T78 beam end segment .....	113
Figure 97. Illustration. Modified Florida bulb-T78 beam haunch segment.....	114
Figure 98. Illustration. Modified Florida bulb-T78 beam drop-in segment .....	115
Figure 99. Illustration. Modified Florida bulb-T78 beam end block detail .....	116
Figure 100. Illustration. Typical sections—haunch segment.....	117

## LIST OF TABLES

Table 1. Bridge condition—probability of defect indicator.....	37
Table 2. Construction and inspection records—probability of defect indicator.....	37
Table 3. Visual evaluation—probability of defect indicators.....	38
Table 4. Tendon geometry and length—probability of defect indicators.....	38
Table 5. Weight factors for probability of defect indicator.....	39
Table 6. Consequence of failure indicator versus cost of repair or tendon replacement.....	39
Table 7. Consequence of failure indicator versus element/tendon redundancy.....	40
Table 8. Consequence of failure indicator versus bridge importance.....	40
Table 9. Weight factors for consequence of failure indicator.....	41
Table 10. Acceptable fractions of undetected tendons with deficient grout.....	41
Table 11. Minimum number of tendons required to detect at least one tendon with deficient grout (75 percent confidence).....	44
Table 12. Minimum number of tendons required to detect at least one tendon with deficient grout (95 percent confidence).....	44
Table 13. Balanced cantilever bridge—probability of defect indicator.....	48
Table 14. Balanced cantilever bridge—consequence of failure indicator.....	48
Table 15. Balanced cantilever bridge—minimum recommended number of tendons for inspection.....	49
Table 16. List of continuity tendons.....	50
Table 17. List of external draped tendons.....	51
Table 18. List of selected transverse tendons.....	51
Table 19. List of cantilever tendons.....	52
Table 20. Spliced girder bridge—probability of defect indicator.....	54
Table 21. Spliced girder bridge—consequence of failure indicator.....	54
Table 22. Spliced girder bridge—minimum recommended number of tendons for inspection ...	55
Table 23. List of longitudinal draped tendons.....	55
Table 24. List of diaphragm tendons.....	56
Table 25. List of pier cap tendons.....	56
Table 26. Span-by-span segmental bridge—probability of defect indicator.....	57
Table 27. Span-by-span segmental bridge—consequence of failure indicator.....	57
Table 28. Span-by-span segmental bridge—minimum recommended number of tendons for inspection.....	58
Table 29. PT bridge—probability of defect indicator.....	59
Table 30. PT bridge—consequence of failure indicator.....	59
Table 31. PT bridge—minimum recommended number of tendons for inspection.....	60
Table 32. CD classifications as determined by grout CI <sup>-</sup> levels from an option 1 inspection and resultant recommended actions.....	90
Table 33. CD and PD classifications as determined by grout CI <sup>-</sup> levels and in-place grout structure by an option 2 inspection and resultant recommended actions.....	91

## CHAPTER 1. BACKGROUND

The purpose of this report is to provide guidance for grout sampling, testing, analysis, and interpretation of test results. The following topics are presented and discussed: (1) post-tensioned (PT) bridge types, (2) types of grout deficiencies, (3) statistical approach to grout sampling, (4) grout sampling protocol and test methods, (5) locations for sampling, and (6) interpretation of results and determination of courses of action. Consideration is given to the possibility that extraction of a statistically significant number of samples from PT structures may pose a significant challenge for State transportation departments because of the possibility that invasive inspection and sample acquisition methods might compromise long-term bridge durability and structural integrity.

Durability issues for PT tendons in the United States came to the forefront in 1999 when bridge engineers became aware of failures that resulted from grout voids, associated bleed water, and tendon strand corrosion at higher elevations, such as at anchorages and crest areas. To date, 10 States have reported tendon problems that stem from grout deficiencies or excessive chlorides ( $\text{Cl}^-$ ). (See references 1–4.) Most grouts used for PT bridge construction prior to 2001 consisted of a mixture of cement, water, and added admixtures and were typically mixed at the project site.

To improve grout performance as a corrosion protection method for tendons, the Post-Tensioning Institute (PTI) and some State transportation departments revised their grout specifications between 2001 and 2002. This resulted in the formulation of prepackaged, preapproved thixotropic grouts to eliminate bleed water and thus improve the level of protection provided to PT tendons. Prepackaged grout is a proprietary product that has been widely used in PT bridges since 2001.

While the development of prepackaged thixotropic grouts was thought to provide a solution to the bleed water problem, corrosion-caused tendon failures on relatively new PT bridges have continued to occur. Limited forensic studies involving these newer grouts have revealed the presence of grout segregation, soft grout, bleed water, and high  $\text{Cl}^-$  and sulfate contents. However, not all prepackaged grouts exhibited the above deficiencies. Consequently, it is important to investigate these newer grouts to examine the overall quality of in-place grouts in existing PT bridges. This report is intended as a guide for State transportation departments in this regard.



## CHAPTER 2. OBJECTIVES OF INSPECTION

The overall objective of this study was to develop a general guide for State transportation departments for sampling grouts from external and internal tendons in existing PT bridges. To accomplish this, protocols for sampling grouts with both physical deficiencies (PDs) and chemical deficiencies (CDs) were developed. This report provides a rational approach to extract statistically significant numbers of grout samples for proper interpretation of the corrosion susceptibility to the enclosed strands. At the same time, the sampling approach is such that there is minimal negative impact on the future durability considering both grout sampling location and number.

Specific issues addressed in this report include the following:

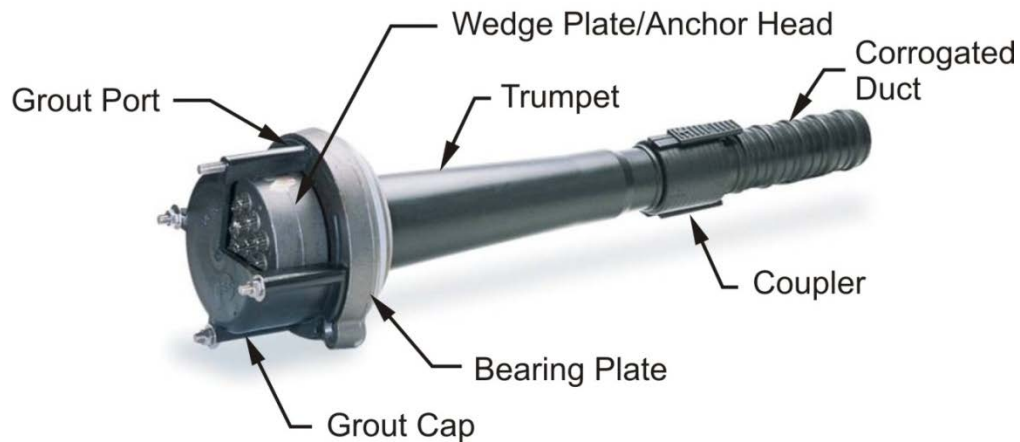
- The types of tendons from which grout samples should be obtained.
- The number of extracted grout samples required from each tendon type on a statistical basis.
- An explanation of proposed methods for retrieving grout samples from tendons, including anchorages, such that any impact on future durability is not compromised.
- Recommendations regarding the amount of grout and the tests required for property characterization.
- Recommendation of a systematic procedure for recording and reporting grout composition in order to define its quality and project its future performance.
- Recommended repair/rehabilitation procedures for tendons in order to minimize the impact on future durability caused by sampling.
- Presentation of a decision path guideline based upon the grout analysis results that recommends future tendon inspection and, if necessary, grout sampling intervals.



## CHAPTER 3. PT SYSTEMS

### BACKGROUND

Anchorage systems in PT bridges are a proprietary system. Systems created by VSL International, Dywidag-Systems International, Freyssinet International, BBR VT International Ltd. (BBR), and Schwager Davis Inc. can be found in PT bridges in the United States. PT anchorage systems differ in shape, size, and material depending on use. In general, a basic PT anchorage system is comprised of a bearing plate, trumpet, wedge plate (anchor head), grout cap, and grout ports (see figure 1). Prior to drilling a hole through the grout port for internal trumpet inspection, it is necessary to determine the PT system used since each system has different grout port orientation and geometry to access the trumpet interior. The simplest way to identify the PT system and its detail is to locate the PT shop drawings for the project, if available.



©VSL International

**Figure 1. Illustration. Basic PT anchorage system.**

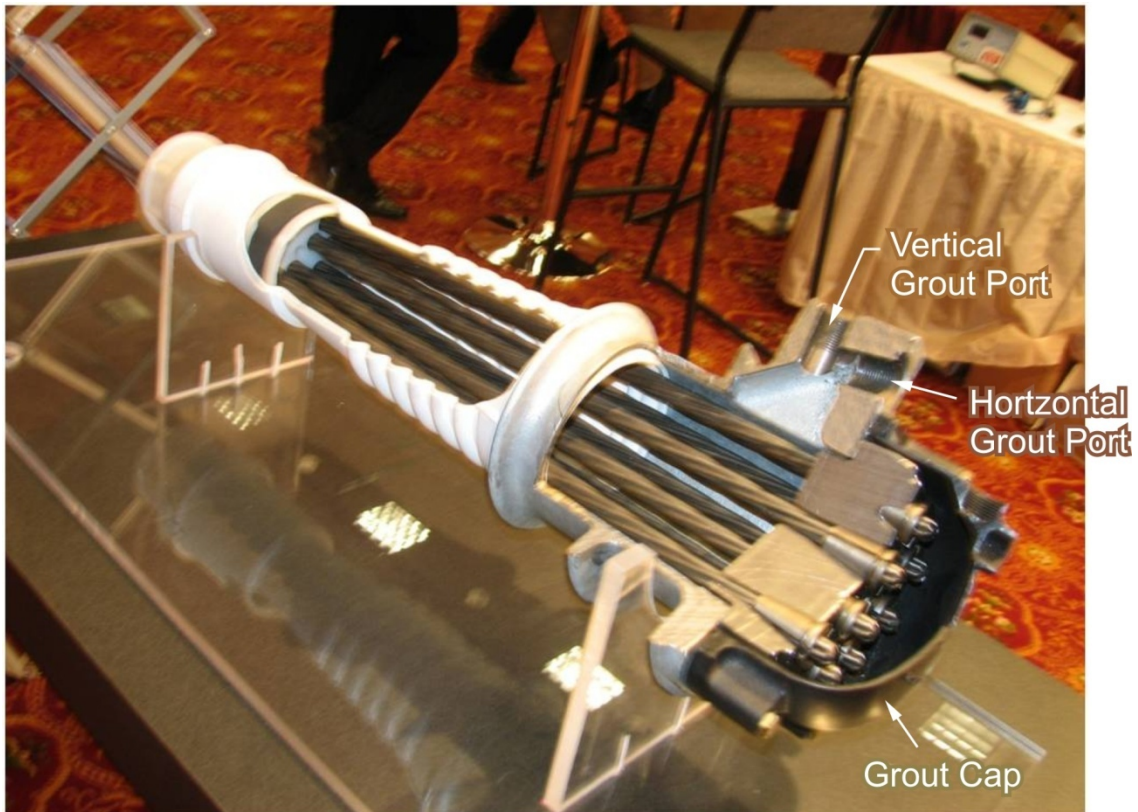
In 2003, the Florida Department of Transportation (FDOT) required an additional vertical grout port/vent located above the trumpet to facilitate post-grouting inspection and permanent grout cap in its PT specifications. The differences between the older and newer generations of PT anchorages systems are shown in figure 2 and figure 3. Many other State transportation departments have adopted PT anchorages with requirements similar to the FDOT requirements. For the new anchorages, the inspection access into the trumpet interior is much simpler through the vertical grout port.





©Dywidag-Systems International

**Figure 2. Photo. Old generation of PT anchorage system.**



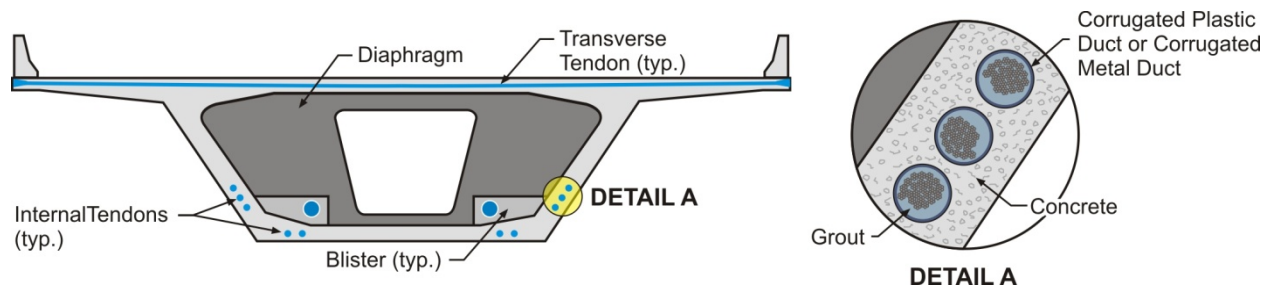
©Dywidag-Systems International

**Figure 3. Photo. New generation of PT anchorage system.**

## PT TENDON TYPES

In general, PT bridges built in the United States consist of grouted internal tendons, grouted external tendons, or a combination of the two. A small number of bridges may also have greased unbonded tendons. This report only focuses on cement grouted tendons, which may be internal or external.

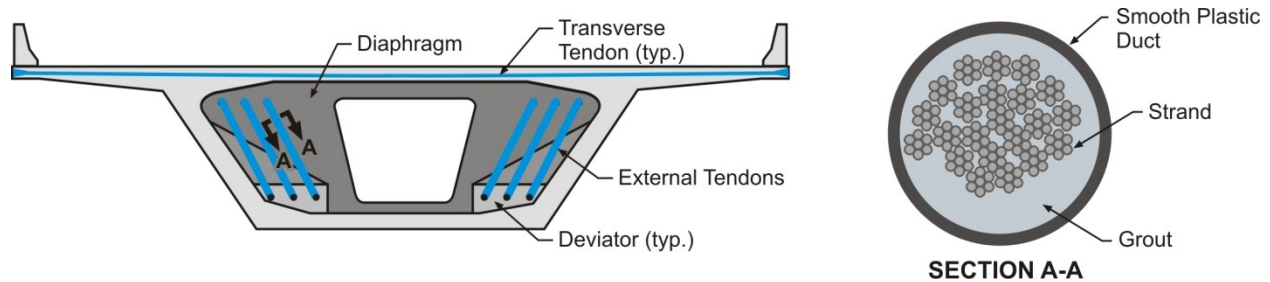
Internal tendons are located inside the structural concrete section, are housed in corrugated metal ducts or corrugated plastic ducts, and are bonded to the structural concrete by means of cementitious grout (see figure 4). The plastic corrugated ducts are made from high-density polyethylene (HDPE) or polypropylene material. The high-strength steel tendon can be strands, wires, or bars.



Source: Parsons Brinckerhoff

**Figure 4. Illustration. Internal tendon.**

External tendons are typically located outside the perimeter of a concrete section, are housed in HDPE smooth duct, and are filled with cementitious grout. External tendons are not bonded with the concrete structural section (see figure 5 and figure 6).



Source: Parsons Brinckerhoff

**Figure 5. Illustration. External tendon.**



Source: Parsons Brinckerhoff

**Figure 6. Photo. External tendons at deviator.**

## **PT BRIDGE TYPES**

PT bridges can be grouped into several categories based on the design and construction methods. Typical possible tendon types used for each bridge group are discussed in the following sections.

### **Cast-in-Place (CIP) PT Box Girder Bridges on False Works**

CIP concrete box girder bridges built on false works consist of single- to multi-cell box girders, as shown in figure 7. Typically, these types of bridges have an internally draped tendon in the webs. In a continuous multispan structure, the PT anchors are anchored in the end diaphragms, and some tendons may be anchored in the intermediate diaphragms. For long-span bridges, additional internal tendons are also provided in the top and bottom flanges and anchored in blisters (see figure 8 and figure 9). The top deck could be either transversely PT or reinforced concrete using mild reinforcement.

PT tendon types include the following:

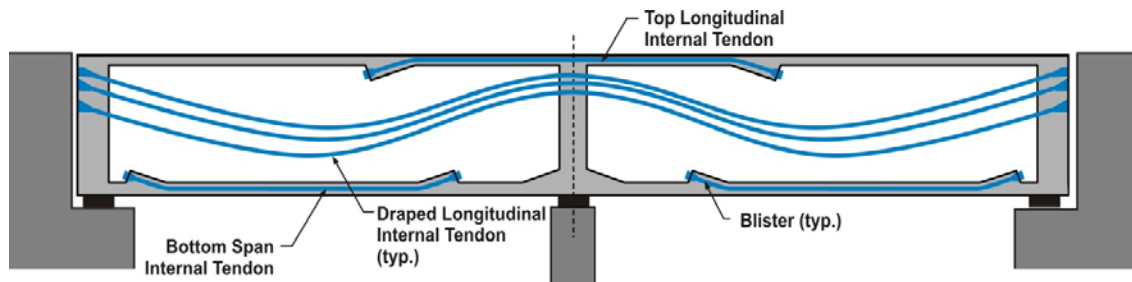
- Draped longitudinal internal tendons in the webs.
- Continuity internal tendons in the bottom flanges.
- Internal longitudinal tendons in the top flange over the piers.

- Transverse internal tendons in the deck.
- Transverse internal tendons in the diaphragm (see figure 10).
- Vertical internal tendons in the diaphragm.

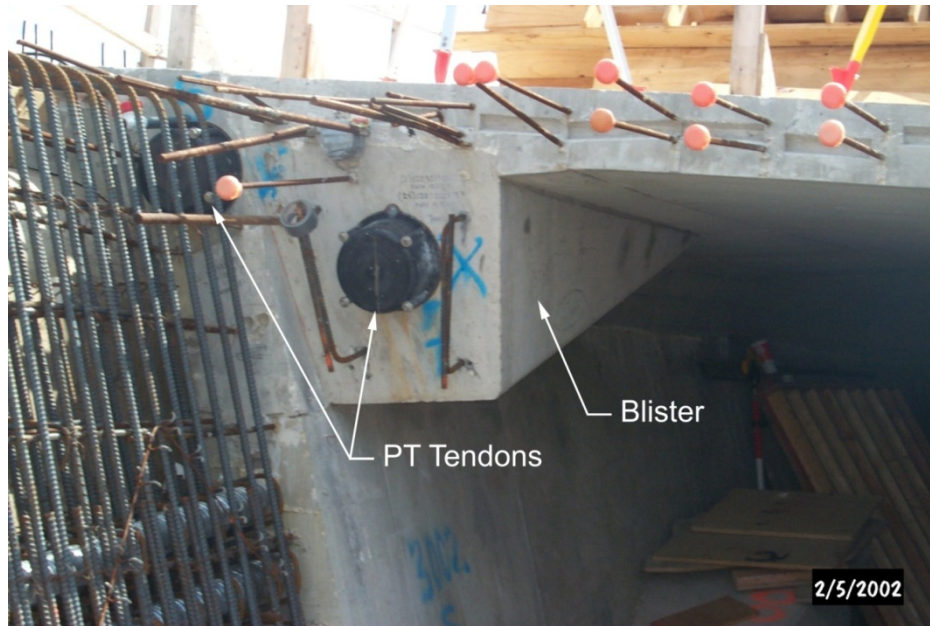


Source: Parsons Brinckerhoff

**Figure 7. Photo. CIP concrete box girder bridge on false works.**

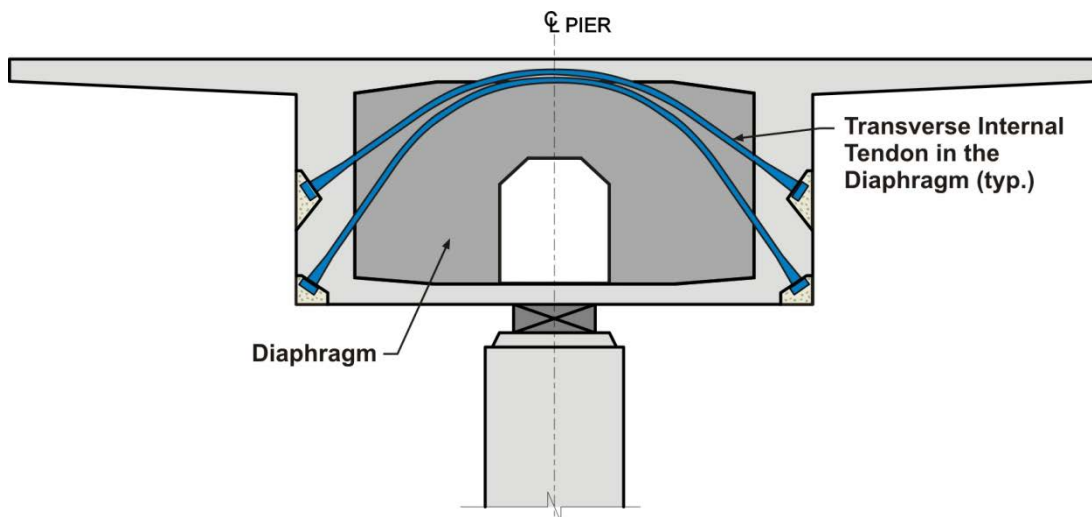


**Figure 8. Illustration. CIP bridge typical tendon layout.**



Source: Parsons Brinckerhoff

**Figure 9. Photo. Blister at the top flange.**



Source: Parsons Brinckerhoff

**Figure 10. Illustration. Transverse internal tendon in the diaphragm.**

### **CIP PT Concrete Slab and T-Girder Bridges**

CIP concrete slab bridges (see figure 11) are very popular for short-span bridges. The CIP PT slab and T-girder bridges are also constructed on false works. Typically, this type of structure has shallow draped longitudinal internal tendons in the deck (see figure 12). In most cases, transverse internal tendons in the deck are also provided. The superstructure may be a single-span or multispan continuous structure from abutment to abutment.

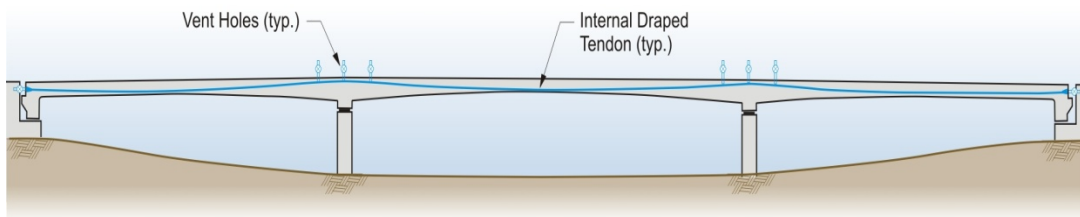
PT tendon types include the following:

- Draped longitudinal internal tendons.
- Transverse internal tendons in deck slab.



Source: Parsons Brinckerhoff

**Figure 11. Photo. CIP PT concrete slab bridge.**



**Figure 12. Illustration. PT slab bridge typical tendon layout.**

### **CIP Segmental Balanced Cantilever Bridge**

CIP segmental box girder bridges (see figure 13) are popular for long-span bridges. They are constructed using the balanced cantilever method with a set of form travelers (see figure 14). The segment is cast against the previous PT segment, which is about 15 ft long. This type of structure utilizes internal cantilever tendons in the top flange over the webs in combination with continuity internal tendons in the bottom flange anchored at blisters (see figure 15). Additional externally draped tendons may also supplement the internal tendons. The top deck is typically transversely PT with tendons encased in flat ducts. For long span bridges, it is also common to use vertical PT bars in the webs of segments close to the pier segment.

PT tendon types include the following:

- Top longitudinal internal cantilever tendons.

- Continuity top and bottom flange internal tendons.
- Longitudinal external draped tendons.
- Transverse internal tendons in the top flange.
- Vertical internal tendons in the webs (see figure 16).
- Vertical internal tendons in diaphragms (see figure 17).
- Transverse internal tendons in diaphragms.



Source: Parsons Brinckerhoff

**Figure 13. Photo. CIP segmental balanced cantilever bridge.**



Source: Parsons Brinckerhoff

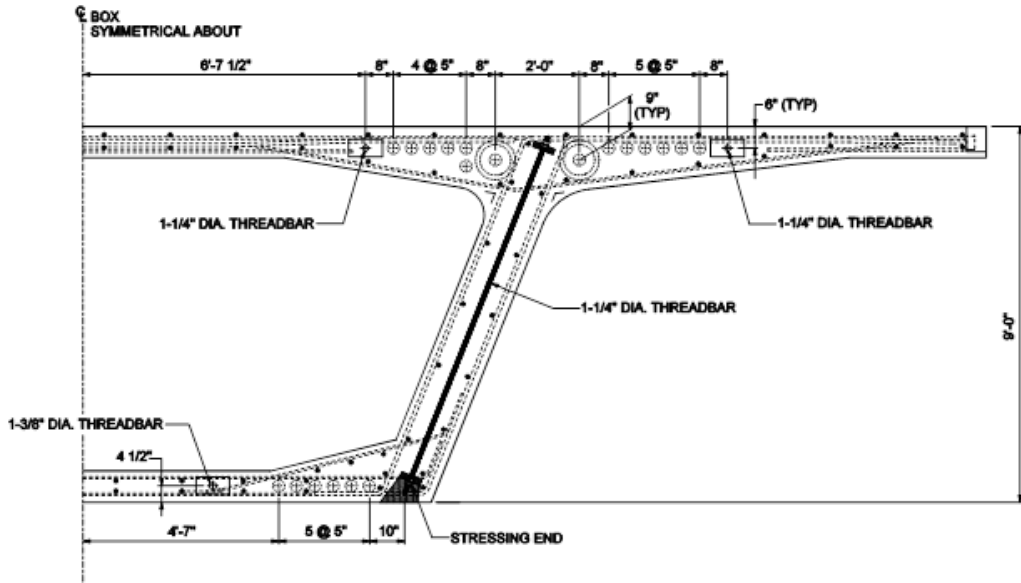
**Figure 14. Photo. CIP balanced cantilever bridge during construction using form traveler.**



Source: Parsons Brinckerhoff

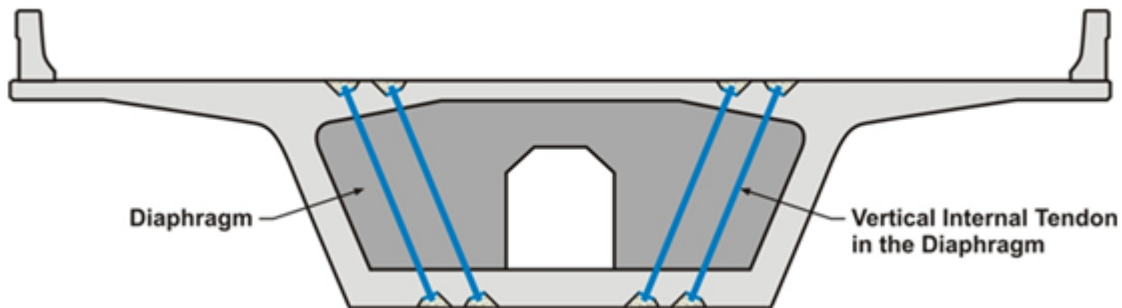
**Figure 15. Photo. Typical bottom flange blister.**





Source: Parsons Brinckerhoff

**Figure 16. Illustration. Typical vertical tendon in the web.**



**Figure 17. Illustration. Typical vertical tendon in the diaphragm.**

### Precast Spliced I-Girder Bridge

Precast spliced girder bridges have been gaining popularity within the last decade for medium-span bridges (see figure 18 and figure 19). Several long pieces of pretensioned American Association of State Highway and Transportation Officials (AASHTO) I-girders or bulb-tee girders are PT using draped internal tendons in the web to form a continuous multispan girder from end to end. The joints between the girders are CIP concrete. The diaphragms are typically cast at the splice locations and are reinforced concrete or PT transversely. A temporary support is provided at the CIP joint locations to stabilize the structure until the girders are made continuous. The deck slab is CIP after the first PT stage is applied. The final PT is applied after the CIP deck slab reaches minimum concrete strength.

PT tendon types include the following:

- Draped longitudinal internal tendon.
- Transverse internal tendons in the diaphragm at CIP joints.



Source: Parsons Brinckerhoff

**Figure 18. Photo. Precast spliced girder bridge.**



Source: Parsons Brinckerhoff

**Figure 19. Photo. Precast spliced girder bridge during erection.**

### **Precast Spliced U-Girder Bridge**

Similar to precast AASHTO I-girder bridges, precast spliced U-girder bridges have also been gaining popularity recently for medium-span bridges, especially horizontally curved bridges

(see figure 20 and figure 21). Several long segments of pretensioned or PT U-girders are PT using draped internal tendons in the web to form a continuous multispan girder from end to end. The joints between the girders are CIP concrete. The diaphragms are typically cast at the splice locations and are reinforced concrete or PT transversely. A temporary support is provided at the CIP joint locations to stabilize the structure until the girders are made continuous. The CIP deck slab is placed after the first stage PT is applied and the rest of the PTs are stressed after the CIP deck is hardened.

PT tendon types include the following:

- Draped longitudinal internal tendon.
- Transverse internal tendons in the diaphragm at CIP joints.



Source: Summit Engineering Group

**Figure 20. Photo. Precast spliced U-girder bridge during erection.**



Source: Summit Engineering Group

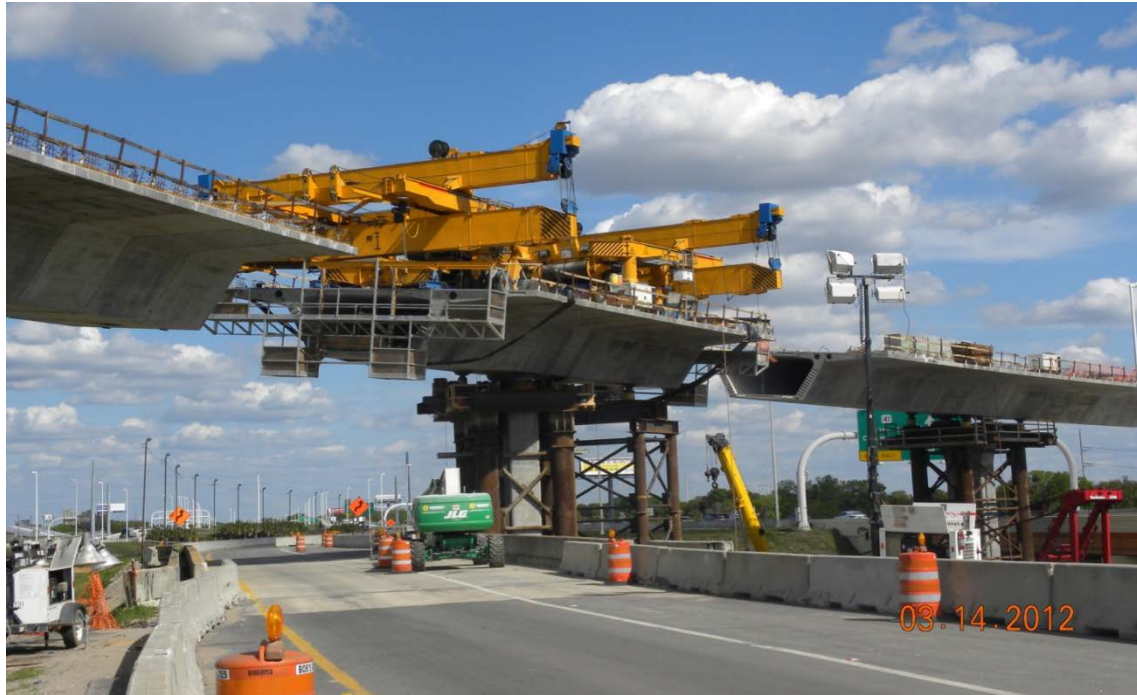
**Figure 21. Photo. Precast U-girder supported on temporary false work.**

### **Precast Segmental Balanced Cantilever Bridge**

Precast segmental balanced cantilever bridges are erected using the balanced cantilever method either with an overhead gantry, a beam and winch, a segment transporter/lifter, or a ground-based crane (see figure 22). The segments are precast using match cast in short-line or long-line casting yard that is about 10 to 12 ft long. During segment erection, epoxy is applied at the match cast joints and stressed by internal cantilever tendons in the top flange.

PT tendon types include the following:

- Longitudinal cantilever internal tendons.
- Continuity top and bottom flange internal tendons.
- Longitudinal externally draped tendons.
- Transverse internal tendons in the top deck.
- Vertical internal tendons in the webs.
- Vertical internal tendon in the diaphragms.
- Transverse internal tendon in the diaphragms.



Source: Parsons Brinckerhoff

**Figure 22. Photo. Precast segmental balanced cantilever bridge erection using a segment lifter.**

### **Precast Segmental Span-by-Span Bridge**

Precast span-by-span bridges consist of precast match cast segments that are 10 to 12 ft long and erected using an under-slung gantry or an overhead gantry as shown in figure 23. The entire span is temporarily supported by overhead or under-slung gantry stressed together using PT bars after epoxy is applied on the match cast joint. The CIP joints are cast between precast segments and the diaphragm segments. Permanent longitudinal external tendons are PT from both diaphragms to complete the span construction. The process is repeated at the next adjacent span.

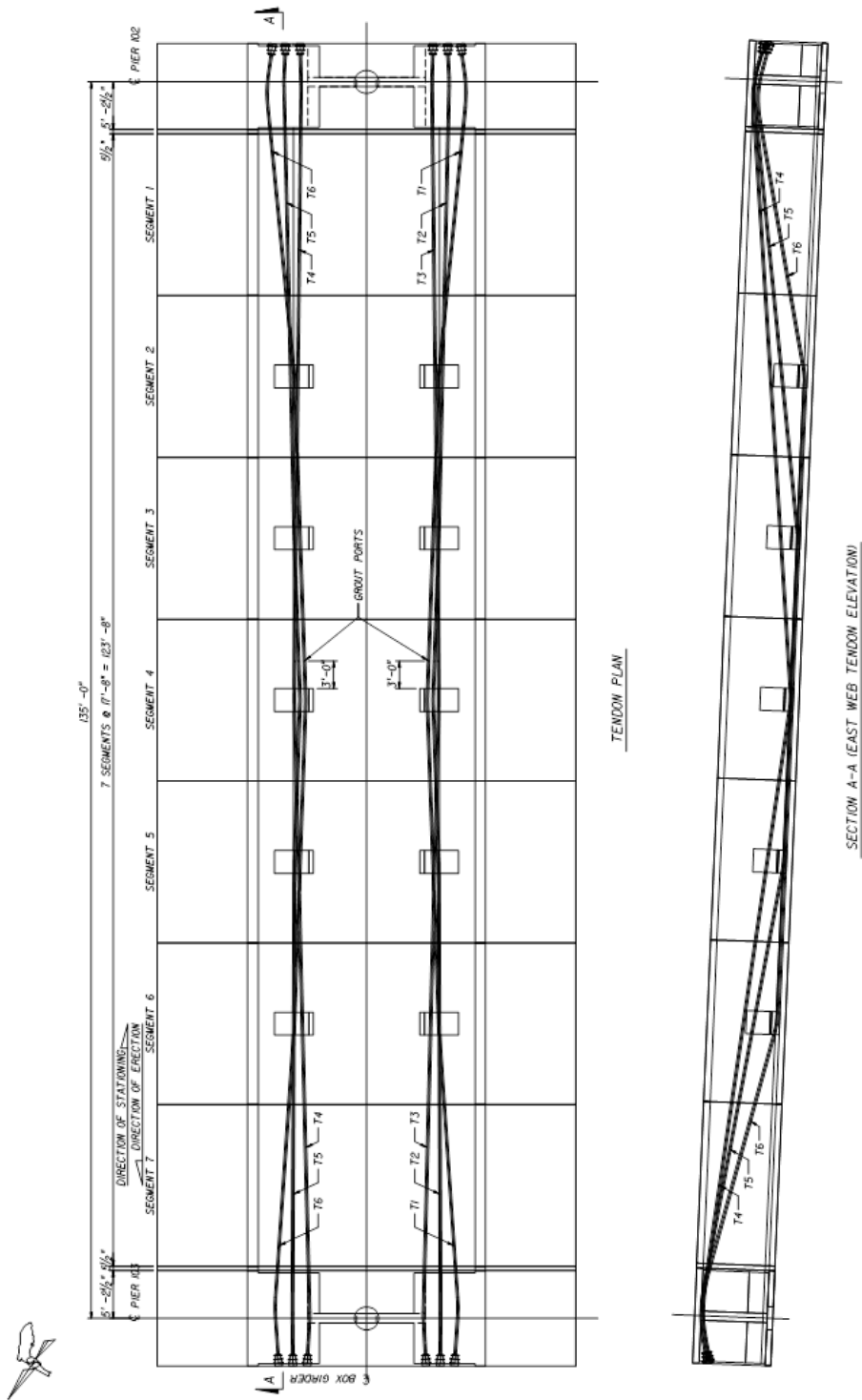
PT tendon types include the following:

- Longitudinal external tendons (see figure 24).
- Continuity bottom internal tendons (optional).
- Transverse internal tendons in the top flange.
- Vertical internal tendons in the diaphragms.
- Transverse internal tendons in the diaphragms.



Source: Parsons Brinckerhoff

**Figure 23. Photo. Precast segmental span-by-span erection using an overhead gantry.**



Source: Parsons Brinckerhoff

**Figure 24. Illustration. Typical precast segmental span-by-span external PT tendon layout.**

## Concrete Cable-Supported Bridge

There are three types of concrete cable-supported bridges in the United States as follows:

- CIP cable-stayed bridge.
- Precast segmental cable-stayed bridge (see figure 25).
- Extradosed segmental bridge.

The superstructure of concrete cable-supported bridges can be precast box girder or CIP deck consisting of two edge girders and transverse floor beams.

The CIP cable-stayed bridge concrete deck construction typically utilizes a set form traveler and is constructed with a balanced cantilever construction method. The previously cast segments are supported by stay cables until the CIP deck reaches the mid-span. Next, a closure segment is placed between the two tips of cantilevers. The CIP deck is typically designed in the form of PT transverse floor beams supported on reinforced concrete edge girders where the stay cable anchorages are located. The pylons and pier columns can be CIP or precast elements with vertical PT.

The precast segmental cable-stayed bridge deck consists of precast box girders. The construction method of the precast deck is very similar to a precast segmental balanced cantilever bridge, except the previously erected segments are supported by stay cables. The segments are PT longitudinally with internal grouted tendons, external tendons, and internal transverse tendons, including diaphragm tendons. The pylons and pier columns can be CIP or precast elements with vertical PT.

An extradosed segmental bridge is a hybrid between a balanced cantilever bridge and a cable stayed bridge and has a very low tower height-to-span ratio. The superstructure of an extradosed bridge is very similar to CIP or precast segmental cable stayed bridges.

The pylon cross beams that support the superstructure of the three types of cable-stayed bridges are normally PT with internal tendons.

PT tendon types include the following:

- Longitudinal cantilever internal tendons (box girder).
- Longitudinal draped external tendons (box girder).
- Continuity bottom internal tendons (optional).
- Transverse internal tendons in the top flange (box girder).
- Transverse internal tendons in the floor beam.
- Transverse internal tendons in the pylon cross beam.



- Vertical internal tendons in the diaphragms.
- Transverse internal tendons in the diaphragms.



Source: Parsons Brinckerhoff

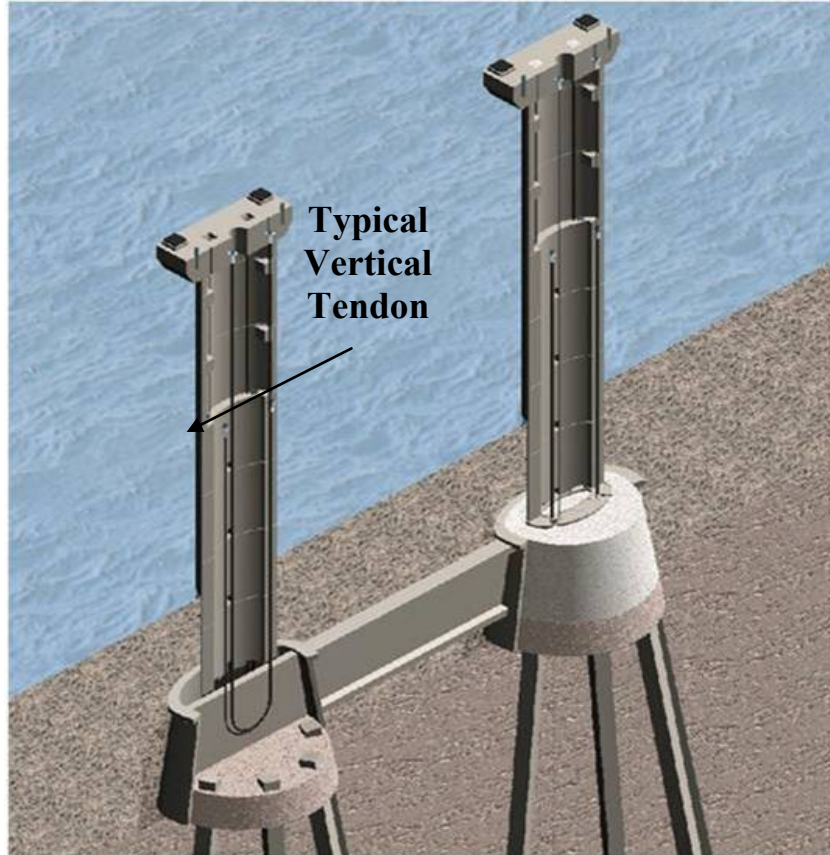
**Figure 25. Photo. Precast segmental cable stayed bridge.**

### **Special PT Concrete Substructures**

Aside from the previously listed superstructure bridge types, PT substructures such as PT segmental precast piers (see figure 26), pylon or CIP PT straddle bents (see figure 27), C-bents, pier caps, and pile caps are also common. Most of these structures utilize internal tendons except segmental precast piers—internal, external vertical PT, or combined.

PT tendon types include the following:

- Horizontal/longitudinal internal tendons.
- Vertical internal or external tendons or a combination of both.



**Typical  
Vertical  
Tendon**

Source: Parsons Brinckerhoff

**Figure 26. Illustration. Cross section of precast segmental columns.**



**PT Anchorages**

Source: Parsons Brinckerhoff

**Figure 27. Photo. PT straddle bent during construction.**



## CHAPTER 4. GROUT DEFICIENCIES

### BACKGROUND

The first line of corrosion protection of grouted PT tendon relies on adequate sealing of ducts from external sources of corrodants (i.e., water, air,  $\text{Cl}^-$ , and carbon dioxide), while the second line of corrosion protection relies on encasement and direct contact of strands with a cementitious grout for which a high pH ( $> 13$ ) is maintained. Thus, if strands are inadequately grout coated, protection may still be feasible if the duct is adequately sealed and there are no internal sources of corrodants. Alternatively, even if the first protection (by duct) is lacking, the grout acts as a secondary protection to the PT tendon. A necessary but not sufficient condition for strand protection is that  $\text{Cl}^-$ , either as a background grout contaminant or from an external source, is maintained below a critical concentration.

PTI, the American Concrete Institute (ACI), and AASHTO all list 0.08 weight (wt) percent cement as an upper acid soluble  $\text{Cl}^-$  limit for PT grout or prestressed concrete. (See references 5–8.) The applicable European standard lists this upper limit as 0.10 wt percent cement.<sup>(9)</sup> In sufficient concentration,  $\text{Cl}^-$  facilitates corrosion of conventional reinforcement and PT strand by transitioning steel from a passive state for which corrosion rate is negligible to an active one where corrosion rate may be unacceptably high and reducing grout electrical resistivity, thus minimizing macrocell activity and a higher corrosion rate than would otherwise develop. The disclosure that grout may have  $\text{Cl}^-$  concentrations greater than the above limit (0.08 wt percent cement) and that approximately 100 PT bridge projects may have utilized this material has prompted immediate concerns regarding the long-term integrity of these bridges and a need for reactive strategies and actions. In the limited PT tendon grout sampling that has been performed to-date on a bridge that utilized this  $\text{Cl}^-$  contaminated grout,  $\text{Cl}^-$  concentrations as high as 5.27 wt percent grout<sup>1</sup> were reported.<sup>(1)</sup> However,  $\text{Cl}^-$  concentration of this grout may have varied with production variables such that this contaminant was in an acceptable range for some lots but not others. The purpose of this section of this report is to define the deficiencies that are thought to have occurred with the contaminated grout and other PT grouts with emphasis placed on the consequences of  $\text{Cl}^-$  concentration possibly being in excess of the above specified limit of 0.08 wt percent cement.

### $\text{Cl}^-$ Threshold

The corrosion process in cementitious materials such as PT grout involves two phases: (1) a time to corrosion initiation,  $T_i$ , during which the steel is passive and (2) a period of corrosion propagation,  $T_p$ , to the point where repair, rehabilitation, or replacement becomes necessary. PT strands in grout that have a  $\text{Cl}^-$  concentration below the threshold for active corrosion initiation are normally passive and exhibit a negligible corrosion rate. However, if  $\text{Cl}^-$  is present above a limiting value, passivity is compromised, and active corrosion may occur at an unacceptable rate, provided oxygen and moisture are present. Oxygen and moisture are invariably present in grout pores of atmospherically exposed tendons, although water content may be minimal under extremely dry conditions, and oxygen concentration may be negligible if the grout is water saturated. From the standpoint of strand corrosion, a worst-case scenario arises

---

<sup>1</sup>Approximately two-thirds of grout is typically composed of cementitious material.

in situations where the grout is subjected to repetitive wetting (presumably from periodic water infiltration from a source external to the duct) and drying. Such cycling may also be facilitated by temperature variations. Strand corrosion is particularly severe at an air-water interface. Both  $T_i$  and  $T_p$  are a function of a number of material and exposure variables, which are described in this chapter in conjunction with a discussion of the  $\text{Cl}^-$  concentration threshold.

The  $\text{Cl}^-$  threshold itself,  $C_T$  (i.e., the concentration of this species required to initiate active corrosion) is understood to be greater than 0.08 wt percent cement for good quality, high alkalinity in-place grout, although a definitive concentration has not been defined. This is because  $C_T$  is known to conform to a distribution rather than being a distinct value, and there are a number of variables of influence. For example, air voids greater in diameter than about 0.1 inches that intersect the reinforcement facilitate local premature corrosion initiation. (See references 10–17.) Such occurrences, either involving air voids or relatively large air pockets, result from air entrapment because of inadequate duct venting, incomplete duct filling, strands pressing against the duct interior surface, strand congestion, subsidence, or poor consistency with segregation (or a combination of these). These occurrences have been reported within PT ducts irrespective of the advent during the past decade of thixotropic grouts. (See references 10 and 18–20.) Also, steel corrosion at air-grout interfaces, which can occur in conjunction with the previously listed causes, has been reported even with  $\text{Cl}^-$  concentrations below the prescribed upper limit of 0.08 wt percent.<sup>(21,22)</sup> However, the presence of  $\text{Cl}^-$  should enhance this attack because of steel depassivation or reduced grout resistivity (or both).

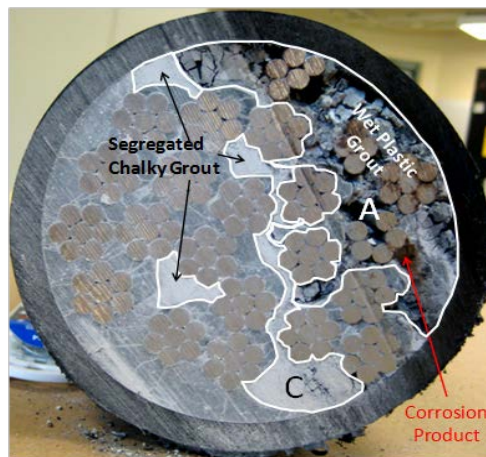
Other variables that have been reported to influence  $C_T$  include mix proportions, cement type, tricalcium aluminate content, concentration of blended materials, water/cementitious materials ratio, temperature, relative humidity, and steel surface condition. However, it can be reasoned that  $C_T$  depends on cement content alone irrespective of whether or not grout, mortar, or concrete is an issue since  $\text{Cl}^-$  predominantly resides in the cement phase.<sup>(23)</sup> As a result,  $C_T$  is normally expressed on a cement wt percent basis. Also, it is the cementitious phase that is predominantly contiguous with conventional reinforcement or bonded PT strand. Thus, for conventional reinforcement, ACI reports  $C_T$  as 0.2 wt percent cement for concrete, whereas Alonso et al. determined  $C_T$  to be in the range of 0.39 to 1.16 wt percent cement (also for mortar).<sup>(24–26)</sup> Mean and standard deviations for  $C_T$  in concrete have been reported as 0.896 and 0.260 wt percent cement, respectively.<sup>(27,28)</sup> While this seems high compared to the other  $C_T$  values listed, the preceding values are not mean values but concentrations at which initial corrosion onset occurred. Thus, if two standard deviations are subtracted ( $0.260 \times 2 = 0.520$ ) from the listed mean (0.896) and if it is assumed that the data are normally distributed, then the result (0.376 wt percent cement) indicates that 2.5 percent of embedded steel should be active at this value. This concentration is in the same range as the other results. However, all the  $C_T$  determinations listed previously are for conventional reinforcing steel embedded in sound cementitious material. Conversely, if steel is exposed in air and if free water is present, then  $C_T$  is essentially 0 wt percent. Because the corrosion rate of active carbon steel in aqueous solutions and in cementitious materials is normally controlled by oxygen availability, variations in alloy composition or microstructure (or both) generally have little influence. Consequently, corrosion behavior of PT strand is expected to be generally similar to that for conventional reinforcement.

## Previous Investigations

Previous forensic investigations of existing bridge tendons with prepackaged thixotropic grouts have reported the following four distinct grout textures/appearances:

- **Type 1:** Segregated wet plastic (soft) grout with a clay-like consistency.
- **Type 2:** Segregated grout with black striated layers.
- **Type 3:** Segregated dry grout with a chalky white consistency.
- **Type 4:** Hardened, gray, dry grout.

Only type 4 has the requisite properties to render it a desired in-place grout. In some instances, all four grout types have been reported in the same general vicinity along tendons. Where multiple grout consistencies occurred, type 4 was typically found along the lower portion of ducts, while types 1 and 2 were found at the highest elevations, indicating that gravimetric forces played a role in the segregation. Regions where grout was segregated often exhibited an air void or pocket along the top of the duct interior. Figure 28 shows a cross section of a tendon subsequent to its failure 8 years after construction.<sup>2</sup>

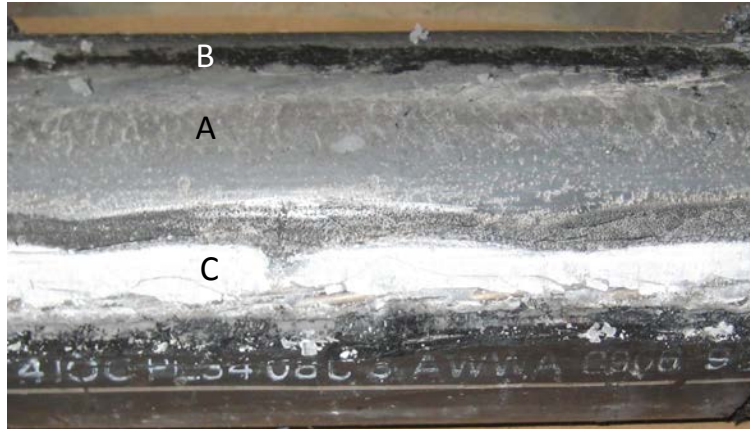


**Figure 28. Photo. Failed tendon cross section.**<sup>(22)</sup>

In figure 28, the strands contact the duct inner surface at the upper-right portion of the tendon, and type 4 grout is apparent in the lower region. Type 3 grout, either outlined or delineated by a somewhat broad white line (labeled “C”), is also apparent at intermediate elevations, and soft, wet grout is seen near the top. As such, in this case, the segregated white grout tended to separate the gray grout from segregated soft, wet grout or air space, which is apparent near the top (labeled “A”). Thus, segregated white grout occurred either as a volume of material embedded in the grout or as an approximately 0.04-inch-thick layer at the top of the gray grout. The type 2 grout (not apparent in figure 28) has been identified as either unmixed or segregated silica fume. Because segregation involved gravimetric causes, the three undesired grout forms have been most pronounced at elevated horizontal locations, near the top of inclines, and at anchorages.

<sup>2</sup> Cl<sup>-</sup> concentration of the grout from this bridge was below the specified 0.08 wt percent cement upper limit.

Although not necessarily identifiable in figure 28, corrosion products are contiguous to the upper strands. Figure 29 shows a longitudinal overhead view of the strands and grout in figure 28 with the duct top half removed and all three segregated grout types identified. Section A shows type 1 segregated wet, soft grout, B shows type 2 black segregated grout, and C shows type 3 segregated chalky white grout.



**Figure 29. Photo. Longitudinal section of a tendon section with types 1–3 grout identified.**<sup>(22)</sup>

Figure 30 and figure 31 show opened tendon anchorages. In these cases, there was no grout contamination by  $Cl^-$ , and grout filling of the duct was complete. However, regions of varied grout quality and strand corrosion products are apparent. For example, the grout in figure 30 consists predominantly of type 3 grout with an interconnecting network of cracking. Corrosion products at some of the strand ends are also visible. Figure 31 illustrates much the same but with type 1 grout in the central region. Figure 32 is similar to figure 31 but with type 4 grout in the bottom region. Thus, poor grout quality for these ducts is pervasive.

Figure 33 shows an opened anchorage on the Carbon Plant Road bridge over IH-37 in Texas as reported by the Texas Department of Transportation (TxDOT).<sup>(1)</sup> Type 1 grout is seen in the upper region, while the lower portion consists of type 4 gray grout. Free water flowed from the anchorage upon opening, and corrosion of strands in the type 1 grout and air space was apparent.



Source: Parsons Brinckerhoff

**Figure 30. Photo. Opened tendon end showing predominantly type 3 grout and strand corrosion products.**



Source: Parsons Brinckerhoff

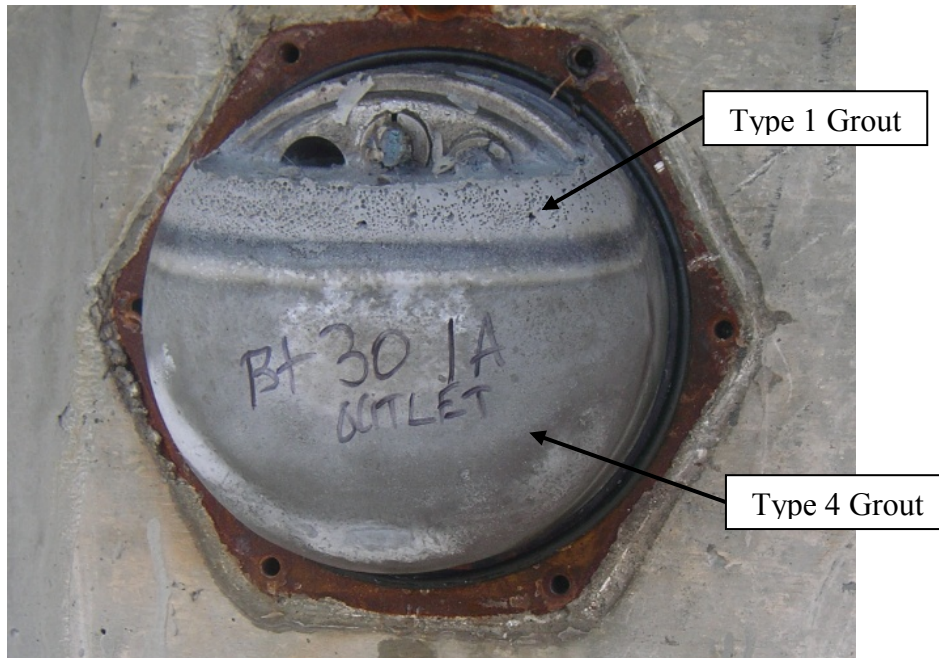
**Figure 31. Photo. Opened tendon end showing types 3 and 1 grout and strand corrosion products.**





Source: Parsons Brinckerhoff

**Figure 32. Photo. Opened tendon end revealing type 4 grout (bottom half), type 1 grout (center region), and strand corrosion products (upper region).**



**Figure 33. Photo. Opened anchorage on the Carbon Plant Road bridge over IH-37.<sup>(11)</sup>**

Bertolini and Carsana reported forensic analysis results for a PT bridge for which a tendon failure was disclosed less than 2 years after construction.<sup>3(21)</sup> The cementitious grout was not identified by the manufacturer or as being thixotropic; however, a water/cement ratio of 0.32 was

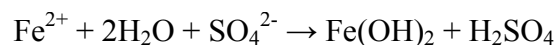
<sup>3</sup> The location of this bridge was not provided, but it is assumed to be in Italy.

specified along with a commercial unidentified admixture specific for PT grouts. While most tendons examined were characterized as consisting of type 4 grout, some, including the anchorage area of the failed tendon, had a whitish unhardened plastic paste, which could be a combination of types 1 and 3. Such regions contained small hardened black spots, which could be type 2 grout. Heavy strand corrosion occurred in areas of the whitish grout.

The limited findings suggest the possibility that segregation and as many as four different textures/consistencies can result for in-place grouts with active strand corrosion occurring for segregated grout types 1–3.<sup>(1,21,22)</sup> These studies identified air voids/pockets as a major problem and indicated that upward water migration through the grout occurred during setting. The TxDOT study identified  $\text{Cl}^-$ , sulfide ( $\text{S}^{2-}$ ), sodium ( $\text{Na}^+$ ), and potassium ( $\text{K}^+$ ) in type 1 grout, and FDOT found higher levels of  $\text{Cl}^-$  and calcium ( $\text{Ca}^{2+}$ ) in type 1 in comparison to the other types.<sup>(1,22)</sup>

Using an ex-situ leaching method, FDOT measured higher  $\text{Cl}^-$  concentrations at upper compared to lower elevations within a given duct cross section, suggesting that upward migration of this species occurred during grout setting.<sup>(22)</sup> The concentrations measured at elevated positions were relatively low (maximum ~0.04 wt percent), which was consistent with this grout not necessarily being from  $\text{Cl}^-$  contaminated batches. Also, any partitioning trend for sulfates ( $\text{SO}_4^{2-}$ ) between grout types was less distinct than for  $\text{Cl}^-$  and  $\text{Ca}^{2+}$ ; however,  $\text{SO}_4^{2-}$  concentrations as high as 0.9 wt percent were found in the type 1 grout free water. Sulfates are invariably present in cement pore water, and several authors have associated this species with steel depassivation or passive current densities being an order of magnitude or more higher than for  $\text{SO}_4^{2-}$  free simulated pore water solutions as well as passivity breakdown events. (See references 29–31 and 22.) Based on anodic polarization and immersion experiments in saturated calcium hydroxide solutions, Gouda reported the critical  $\text{SO}_4^{2-}$  concentration for initiation of active steel corrosion as 0.2 percent.<sup>(30)</sup> One recommendation has been that the grout maximum cement  $\text{S}^{2-}$  content be limited to 0.01 percent.<sup>(19)</sup> Schokker and Musselman reported advanced strand corrosion after relatively brief exposure periods in test assemblies that employed a standard commercial gypsum (hydrated calcium sulfate) grout and contiguous air space but no free water for the purpose of simulating a tendon failure in the Varina-Enon bridge in Virginia.<sup>(31)</sup> Bertolini and Carsana measured elevated  $\text{SO}_4^{2-}$ ,  $\text{Na}^+$ , and  $\text{K}^+$  in the tendon grouts they examined and attributed strand corrosion and resultant fracture to the elevated pH range where the soluble hydrous iron oxide ( $\text{HFeO}_2^-$ ) corrosion product has been reported and low water resistivity was observed (1.64 ohm-ft).<sup>(21,31)</sup> Although thermodynamically feasible, such a role of  $\text{HFeO}_2^-$  has not been previously reported. It is projected that sulfates were responsible. The European standard lists an upper limit of 4.5 wt percent cement for sulfates and 0.01 wt percent cement for sulfides.<sup>(9)</sup>

In addition, sulfates may cause electrolyte acidification within occluded regions (crevices), such as the lines of contact between adjacent wires or strands where the solution becomes deaerated. The process is normally described in standard corrosion texts as involving  $\text{Cl}^-$  rather than  $\text{SO}_4^{2-}$ , since the former is generally more pervasive; however, any hydrolysable ions, including sulfates, can have the same effect.<sup>(33)</sup> Thus, the reaction at issue is as follows:



**Figure 34. Equation. Reaction of the ferrous ion with water and sulfate ion to yield ferrous hydroxide and sulfuric acid.**

Where sulfuric acid is a product. Because of the resultant drop in pH, corrosion rate in such circumstances is expected to be much greater than if the solution were near neutral or alkaline.

### **Deficiencies**

Based on the findings discussed in this chapter, the following grout deficiencies are of concern:

- Grout subsidence such that strands become exposed in resultant air space.
- Grout segregation resulting in grouts (some unhardened) and free water with high concentrations of corrosive ions ( $\text{Cl}^-$  and  $\text{SO}_4^{2-}$ ) in the upper vicinity of tendons and at high tendon elevations that facilitate corrosion.
- $\text{Cl}^-$  concentrations in excess of the upper 0.08 wt percent cement limit specified by PTI, AASHTO, and ACI. (See references 5–8.)

The finding that corrosion-induced tendon failures have occurred relatively soon after construction compared to the intended service life, even in situations where  $\text{Cl}^-$  concentrations were relatively low and within the prescribed 0.08 wt percent cement limit, strongly indicates that segregation, subsidence, and incomplete duct filling are major issues.<sup>(1,21,22)</sup> Corrosion that occurs in such situations is likely to be enhanced by elevated  $\text{Cl}^-$  but will still initiate and propagate even if  $\text{Cl}^-$  concentrations are below the 0.08 wt percent limit.

## CHAPTER 5. MINIMUM NUMBER OF TEST SAMPLES

### GENERAL

The determination of the number of tendons to be inspected for grout sampling is an important part of this guideline. If not enough samples are collected, the inspection may not provide a good assessment of the actual condition in the bridge. However, if too many samples are removed, it may be too costly and, without proper restoration, may result in future durability issues. It is critical to select a reasonable number of tendons for each tendon type based on practical and logical considerations such as tendon redundancy, function, workmanship, complexity, detailing, etc. For instance, the recommended number of samples for a relatively straight short horizontal tendon will be different than for a long-draped tendon or a cantilever tendon. This chapter provides guidance on the determination of a reasonable number of sampling locations for each type of tendon by utilizing a statistical risk-based approach to categorize and rank the elements of the PT system. The recommended numbers can be adjusted on a case-by-case basis.

As previously stated in chapter 4, there are two main sources of grout deficiencies as follows:

- Grout material/constituent CDs (e.g., elevated  $\text{Cl}^-$ , sulfate, or other).
- Grout PDs (e.g., grout void, segregated, and soft grout).

A single lot of grout typically varies in size from about 40,000 to 250,000 lb. Each lot consists of a series of batches about 1,100 lb each. It is expected that for the contaminated grout, the  $\text{Cl}^-$  content will be uniform within each batch, but the  $\text{Cl}^-$  content may differ slightly between batches in a single lot.<sup>(34,35)</sup> Depending on the size and length of a certain tendon, it is likely that the grout of each tendon originated from several batches.

Assuming that deficiencies stem from only grout material contamination, relatively few samples may be required for tendons grouted with the material from a single lot, provided the tendon grouting log information is available. In cases where tendons are grouted with multiple grout lots, a greater number of grout samples will be required in order to best assure that as many lots are included in the sampling as possible. However, the grout log information may not be available for every bridge. Therefore, the statistical grout sampling method is a reasonable approach as it is implemented in other fields in the industry by ASTM E141-10, “Standard Practice for Acceptance of Evidence Based on the Results of Probability Sampling.”<sup>(36)</sup>

Deficiencies caused by poor workmanship may require more samples because the variation in workmanship is likely to be more random in nature, and there may not be any correlation between different grouting locations. The two main sources of deficiencies can occur independently or concurrently at the same location. The combined effects of deficiencies and the uncertain nature of any poor workmanship complicate the formulation of the quantitative basis for an optimal and cost effective grout sampling/inspection program.

## INSPECTION OPTIONS

In some cases, bridge owners may be concerned with the  $\text{Cl}^-$  contamination only. Therefore, the inspection guidelines provided in this chapter contain the following two options with two different inspection plans, as shown in figure 35:

- **Option 1:** Inspection for  $\text{Cl}^-$  concentration in the tendon grout.
- **Option 2:** Inspection for all grout deficiencies, including the determination of  $\text{Cl}^-$  concentration.

In both options, the inspection is performed in two levels. Recognizing that invasive testing may create paths that allow corrodants access to strands and cause corrosion if the tendon is not properly restored/repared, level 1 is intended to provide an initial indication of the grout condition in terms of preliminary screening tests, while level 2 provides a more comprehensive and higher confidence result. Bridge owners have the flexibility to select the inspection strategy and level of confidence and modify the inspection plans/procedures as appropriate for their bridge inventory and local conditions.

For owners who are only concerned with the grout  $\text{Cl}^-$  contamination, the sampling procedure for option 1 should be followed. Otherwise, the sampling procedure for option 2 is followed, as shown in figure 35.



**Figure 35. Flowchart. Inspection options.**

Option 2 adopts 75 and 95 percent confidence levels for levels 1 and 2, respectively. The 75 percent confidence approach requires fewer samples than the 95 percent confidence, but it should still provide reasonable findings.

### INSPECTING $\text{Cl}^-$ CONTENT (OPTION 1)

Option 1 assumes no grout PDs, voids, or strand corrosion. If grout PDs are found during sampling, it is recommended to perform an option 2 inspection.

#### Project with Complete Grouting Records

##### *Level 1*

Under this approach, either a minimum of three random samples is taken for each lot from the primary tendon types, or, alternatively, one sample is taken randomly from 50 percent of all batches (one sample per batch) depending on whichever of the two is larger (see chapter 7 for

recommended locations of grout sampling). If the test results show that one or more samples has a  $Cl^-$  content higher than the threshold limit (0.08 wt percent cement), then a level 2 inspection is required. If all analysis results are below this limit, then no further sampling is required.

### ***Level 2***

Under this approach, a minimum of one random grout sample for each batch from the primary tendon types should be obtained (see chapter 9 for the interpretation of the test results for any further actions).

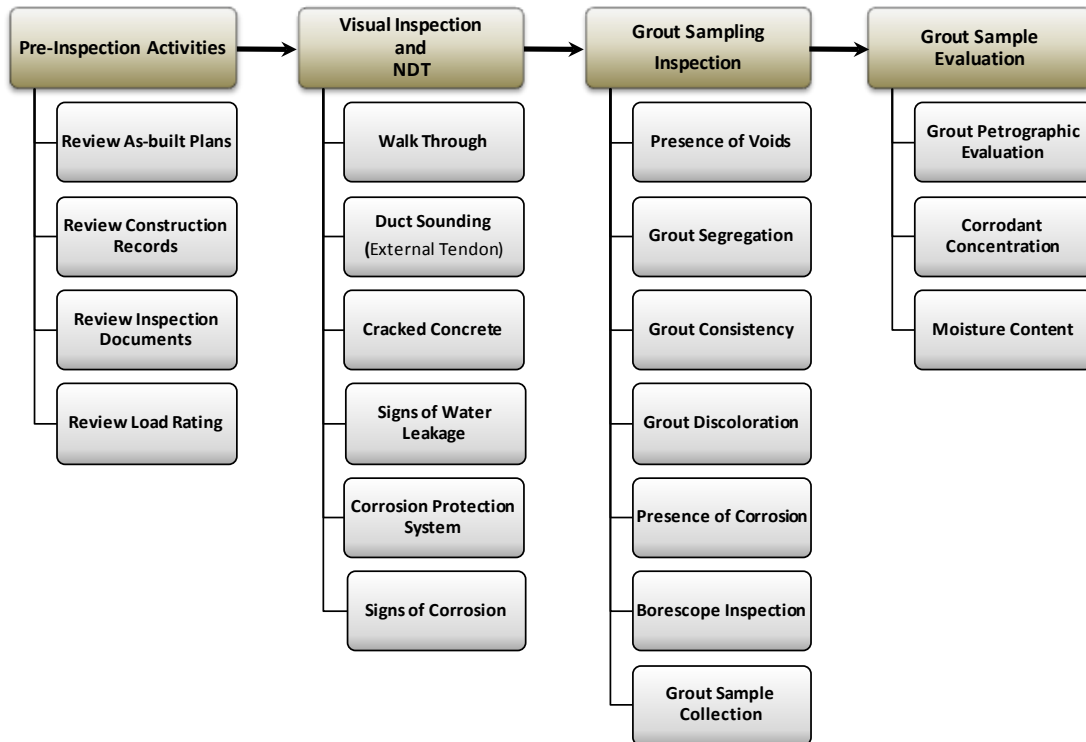
### **Project with Incomplete or No Grouting Records**

Grout sampling for this type of project should follow the procedures based on statistical methods of sampling for all grout deficiencies (option 2).

### **INSPECTING ALL GROUT DEFICIENCIES (OPTION 2)**

In general, the inspection process is performed in four steps (see figure 36). In the first step, an engineer should review the as-built plans, PT shop drawings, specifications, and construction records. Then, the engineer should conduct a walk-through visual inspection for the length of the bridge. The main objective of the walk-through inspection is to evaluate the overall condition of the structural system and identify possible defects and signs of deterioration. The visual inspection does not require any specialized equipment. The third step is to obtain grout samples and visually assess and document the grout condition and any signs of tendon defects.

Depending on the type of structure/tendon, some specialized equipment/tools might be necessary. At this point, the possibility of causing a “weak spot” or distress in the element (e.g., tendon damage during drilling) and rendering it prone to corrosion in the future if not properly repaired becomes an important factor in selecting the number of tendons for sampling. Therefore, it is important to minimize the number of sampled tendons while still providing an acceptable level of accuracy in representation of the grout chemical composition and condition. Chapter 7 of this report discusses the strategy that should be used to identify and preselect test locations within a tendon that are most likely to have deficient grout.

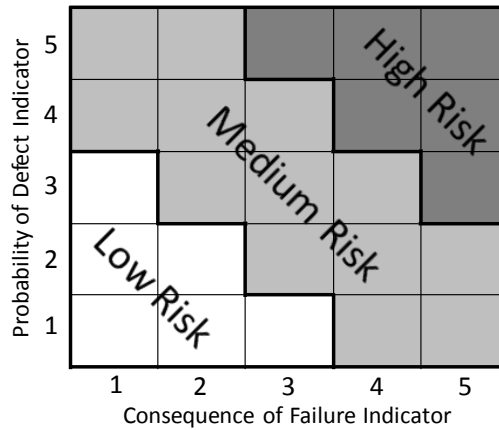


**Figure 36. Flowchart. Grout inspection processes.**

Since there is no quantitative methodology for ranking and identifying deficient areas, the elements of the PT system should be categorized based on the qualitative opinion of experts. The risk-based inspection methodology was adopted, and tendons are prioritized in terms of the risk associated with the potential failure.<sup>(38)</sup> All tendons in the bridge are assigned to one of the following groups:

- Low risk.
- Medium risk.
- High risk.

The risk is expressed as a product of a probability of defect indicator and a consequence of failure indicator, as shown in figure 37. The critical factors influencing risk are defined in terms of a series of tables with designated categories. Numerical values from 1 to 5 are assigned to each category, with 1 being the least probable or lowest consequence, 3 being intermediate, and 5 being most probable with very high catastrophic consequence.



**Figure 37. Graph. Risk matrix.**

**Probability of Defect Indicator**

***Bridge Condition/Service Performance***

The overall condition and previous service performance history of a bridge is an important factor affecting the likelihood of an ongoing corrosion process. Existing serviceability issues such as visible cracks, discoloration of concrete, or poor overall workmanship (or a combination of these) should be considered in assigning this factor. Table 1 lists the probability of defect indicators for the bridge condition categories considered.

**Table 1. Bridge condition—probability of defect indicator.**

<b>Bridge Condition</b>	<b>Description</b>	<b>Value</b>
Poor	Very high degradation probability	5
Moderate	High degradation probability	4
Good	Average degradation probability	3
Very Good	Low degradation probability	2
Excellent	Very low degradation probability	1

***Construction Records***

An important factor affecting the risk associated with the potential tendon failure is the availability of the construction records and previous inspection records. Recommended probability of defect indicators are listed in table 2.

**Table 2. Construction and inspection records—probability of defect indicator.**

<b>Construction and Inspection Records</b>	<b>Value</b>
No construction and inspection records exist	5
Limited construction and inspection records exist	4
Some construction and inspection records exist	3
Comprehensive construction and inspection records exist	2
Very comprehensive construction and inspection records exist	1



### ***Visual Condition Evaluation***

The visual evaluation serves as an important first tool in selecting any problem areas and estimating the likelihood of more serious structural defects. The probability of defect indicators for the visual inspection categories are listed in table 3. The maximum value of the defect indicator should be selected from the list of assigned probability of defect indicators in this category.

**Table 3. Visual evaluation—probability of defect indicators.**

<b>Visual Inspection Category</b>	<b>Major Defect</b>	<b>Moderate Defect</b>	<b>Small Defect</b>	<b>Very Small Defect</b>	<b>No Defect</b>
Signs of grout leakage	5	4	3	2	1
Workmanship	5	4	3	2	1
Cracked concrete	5	4	3	2	1
Duct condition (external PT)	5	4	3	2	1
Voids (external PT)	5	4	3	2	1
Signs of water leakage	5	4	3	2	1
Corrosion protection	5	4	3	2	1

### ***Tendon Geometry and Length***

It was observed from prior investigation experiences that it is unlikely to have defective grout in short straight tendons or tendons with small curvature changes. The likelihood of a defect is higher for multispan long tendons with large curvature changes and large distances between lowest and highest points, particularly tall vertical tendons. The probability of defect indicators for the tendon shape categories are listed in table 4.

**Table 4. Tendon geometry and length—probability of defect indicators.**

<b>Tendon Geometry and Length</b>	<b>Value</b>
Long multispan tendons with large curvature changes/large distance between lowest and highest points; tall vertical tendons	5
Short single-span tendons with large curvature changes/large distance between lowest and highest points; short vertical tendons	4
Long tendons with small curvature changes	3
Long straight tendons or short tendons with small curvature changes	2
Short straight/horizontal tendons	1

### ***Overall Probability of Defect Indicator***

The overall probability of defect indicator,  $P$ , is determined as a weighted sum of the contributing factors as follows:

$$P = \sum P_i W_i$$

**Figure 38. Equation. Overall probability of defect indicator.**

Where:

$P_i$  = Partial probability of defect indicator.

$W_i$  = Appropriate weight factor, as shown in table 5.

**Table 5. Weight factors for probability of defect indicator.**

<b>Probability of Defect Indicator</b>	<b>Weight</b>
Overall bridge condition	0.15
Construction and inspection records	0.15
Visual evaluations	0.30
Tendon geometry and length	0.40

### **Consequence of Failure Indicator**

The consequence of failure indicator is intended to categorize the tendons in terms of the effect that eventual failure due to corrosion resulting from an undetected defect will have on the structure.

### ***Cost of Repair or Tendon Replacement***

The relative cost of repair/replacement accounts for the funding that would be needed to restore the full functionality of the structure after the elements have become damaged or failed. Table 6 presents the consequence of failure indicators in this category.

**Table 6. Consequence of failure indicator versus cost of repair or tendon replacement.**

<b>Rank</b>	<b>Cost of Repair or Tendon Replacement</b>
Very high	5
High	4
Moderate	3
Low	2
Very low	1

### ***Element/Tendon Redundancy***

*Redundancy* is generally defined as the extra capacity of a structural system to carry loads after partial damage or failure of its elements. For example, cantilever tendons have higher redundancy than bottom continuity tendons since a portion of the cantilever tendons is required to support the dead loads and erection equipment during free cantilever construction. After the

cantilever tips from two adjacent piers are connected, the negative moments demand will be reduced. However, the extra tendons are typically left in place. Diaphragm tendons are also considered to have high redundancy due to the presence of a large amount of ordinary reinforcement. The consequence of failure indicators associated with the element/tendon redundancy are listed in table 7.

**Table 7. Consequence of failure indicator versus element/tendon redundancy.**

<b>Element/Tendon Redundancy</b>	<b>Value</b>
Loss of some tendons will cause a catastrophic failure	5
Loss of some tendons will cause severe distress to the structure—repairable	4
Loss of some tendons will decrease the capacity of the structural system—possible need for posting, no structural distress	3
Sufficient safety reserve exists. Loss of a small number of tendons will slightly impact the capacity, but the system can remain in service without posting	2
Tendon does not contribute to the resistance of the structural system	1

### ***Bridge Importance***

The criticality of the bridge as an element of the transportation system is considered in this category. Major bridges carrying large volumes of traffic should be assigned to a high consequence category, while bridges in a rural area with low traffic volumes should be assigned a low number. Recommended consequence of failure indicators for this category are listed in table 8.

**Table 8. Consequence of failure indicator versus bridge importance.**

<b>Bridge Importance</b>	<b>Value</b>
Critical bridges	5
Non-critical bridges	3
Less important bridges	1

### ***Overall Consequence of Failure Indicator***

The overall consequence of failure indicator,  $C$ , is determined as a weighted sum of the contributing factors as follows:

$$C = \sum C_i W_i$$

**Figure 39. Equation. Overall consequence of failure indicator.**

Where:

$C_i$  = Partial probability of defect indicator.

$W_i$  = Appropriate weight factor, as shown in table 9.

**Table 9. Weight factors for consequence of failure indicator.**

<b>Consequence of Failure Indicator</b>	<b>Weight</b>
Cost for repair/tendon replacement	0.4
Element redundancy	0.4
Criticality of the bridge	0.2

**Risk Level**

Figure 37 is used to determine risk level and prioritize/categorize the tendons according to the relationship, as shown in figure 40.

$$RISK = P \times C$$

**Figure 40. Equation. Risk.**

Where:

*P* = Overall probability of defect indicator.

*C* = Consequence of failure indicator.

**Acceptable Fraction of Tendons with Undetected Deficient Grout**

The recommended minimum number of sampled tendons depends on element risk and the possibility of creating distress for the structure through intrusive inspection. The acceptable number of tendons with undetected deficient grout is lower for elements with high risk. Within a risk category, the acceptable number of tendons with undetected deficient grout decreases as the likelihood of structural distress associated with intrusive sampling increases. Table 10 presents recommendations regarding the acceptable number of tendons with undetected deficient grout to categories of element risk and inspection costs.

**Table 10. Acceptable fractions of undetected tendons with deficient grout**

<b>Element Risk</b>	<b>Structural Impact Caused by Sampling</b>		
	<b>High</b>	<b>Medium</b>	<b>Low</b>
High	20 percent deficient	10 percent deficient	10 percent deficient
Medium	30 percent deficient	20 percent deficient	10 percent deficient
Low	30 percent deficient	30 percent deficient	20 percent deficient

**Minimum Number of Inspected Tendons**

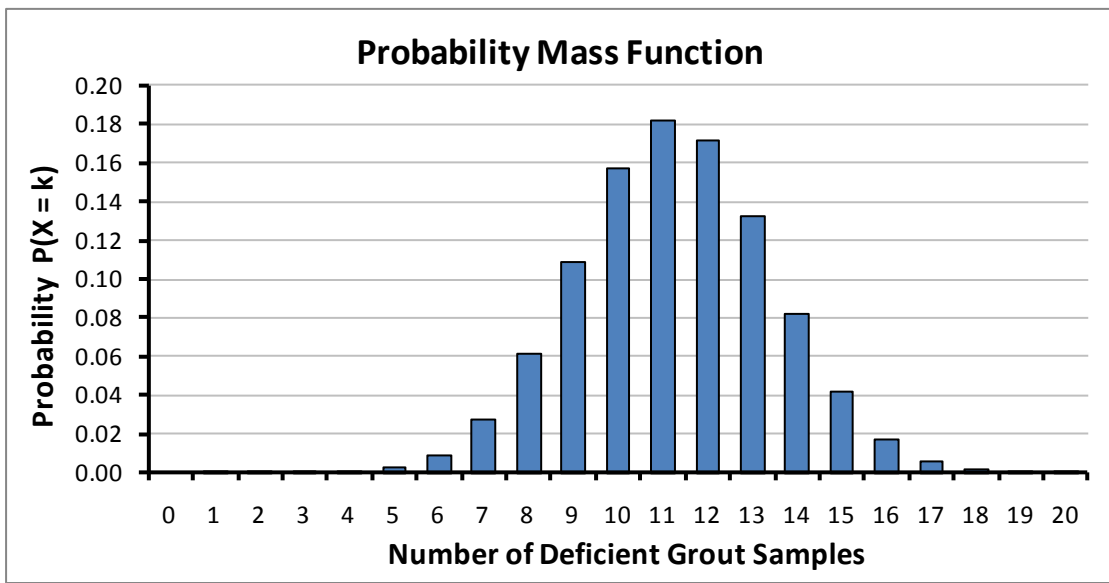
To determine the minimum number of inspected tendons, tendons identified for testing are arranged in groups within which every tendon has approximately the same likelihood of having defective grout; each group is considered as a separate population. Depending on the total number of tendons in one group, *N*, as compared to the number of tendons in that group selected for inspection, *n*, selecting the sample *n* tendons from population *N* might significantly change the remainder of the population regardless of how many tendons with defective grout are in the sample. Therefore, it is assumed that the distribution of the number of tendons with defective grout in a random sample of *n* tendons is an approximately hypergeometric distribution with parameters *m*, *k*, and *N*, where *m* is the actual number of tendons with defective grout and *k* is the

number of times when the selected tendon is with defective grout. The probability mass function (PMF) of this distribution is expressed as follows:

$$P(X = k) = \frac{\binom{m}{k} \binom{N-m}{n-k}}{\binom{N}{n}}$$

**Figure 41. Equation. Probability mass function for hypergeometric distribution.**

Where  $P(k)$  is the probability of observing  $k$  number of deficiencies when selecting without replacement  $n$  samples from the population of size  $N$ .<sup>(39)</sup> Figure 42 presents an example of PMF of the fraction of samples with defective grout calculated for  $N = 100$ ,  $m = 25$ ,  $n = 45$ , and  $k = 1 \dots 20$ . Each bar represents the probability that when 45 tendons are randomly inspected from a total population of 100 tendons,  $k$  tendons will have a defect. Since in this example 25 percent of tendons have defective grout, the expected and most probable number of successes (detection of tendon with defect) is 25 percent of 45, or 11 tendons.



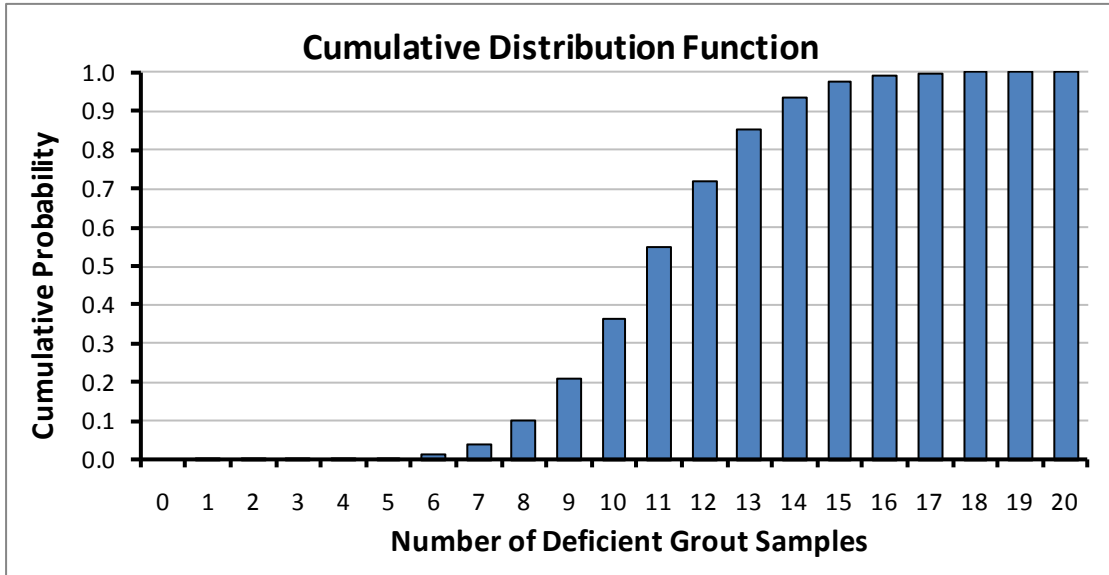
**Figure 42. Graph. Example of PMF for hypergeometric distribution.**

The cumulative distribution function (CDF) of the hypergeometric distribution is defined as follows:

$$CDF = (1 - P_d) = P(i \leq k) = \sum_{i=0}^k \frac{\binom{m}{i} \binom{N-m}{n-i}}{\binom{N}{n}}$$

**Figure 43. Equation. CDF.**

Figure 44 shows CDF for PMF for the example PMF presented in figure 42. Based on the properties of CDF, it can be determined that there is  $(1 - P_d) = 10$  percent probability of discovering not more than eight defective tendons and a  $P_d = 90$  percent chance of discovering eight or more defective tendons where  $P_d$  is defined as the probability of detecting more than  $i$  number of defective tendons in the population of  $N$  with  $m$  tendons being defective.



**Figure 44. Graph. Example of CDF for a hypergeometric distribution.**

Calculations were performed to determine the minimum number of samples required to detect at least one tendon with defective grout, assuming different fractions of tendons with defective grout in the total population. For all considered cases, the probability of detection (confidence of detecting at least one) is set equal to 75 percent (level 1 inspection) and 95 percent (level 2 inspection). The results are presented in the table 11 and table 12. Based on the results in table 12, if 100 tendons are identified in one risk group and eight are initially tested with no defects, then there is a 95 percent probability that the fraction of tendons with defects in the selected population is less than 30 percent. By testing an additional five tendons, it can be assured that there is 95 percent probability that the fraction of tendons with defects in the selected population is less than 20 percent.

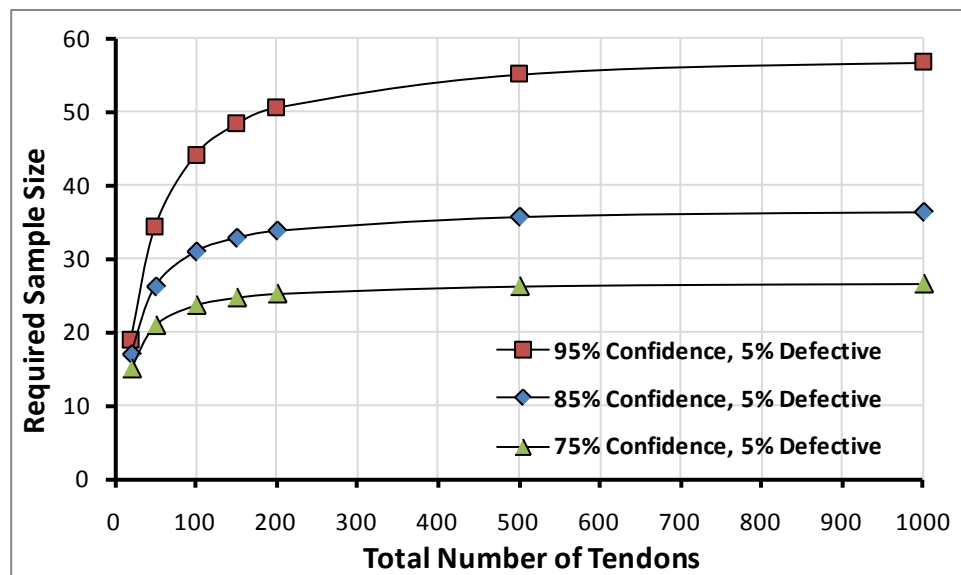
In some cases, it might be necessary to relax the assumptions by decreasing the probability of detecting at least one defective to minimize the number of tendons required to detect at least one tendon with defective grout. Figure 45 to figure 48 present the minimum required number of sampled tendons for confidence levels equal to 95, 85, and 75 percent assuming 5, 10, 20, and 30 percent of the tendons have defective grout. The figures are intended to assist in making informed decisions regarding the sample size to minimize the sampling effort.

**Table 11. Minimum number of tendons required to detect at least one tendon with deficient grout (75 percent confidence).**

Number of Identified Tendons	Percent of Tendons with Deficient Grout		
	10 Percent	20 Percent	30 Percent
10	8	5	3
20	10	5	4
50	12	6	4
100	12	6	4
150	13	6	4
200	13	6	4
500	13	6	4
> 1,000	13	6	4

**Table 12. Minimum number of tendons required to detect at least one tendon with deficient grout (95 percent confidence).**

Number of Identified Tendons	Percent of Tendons with Deficient Grout		
	10 Percent	20 Percent	30 Percent
10	10	7	6
20	15	10	6
50	22	12	7
100	25	13	8
150	26	13	8
200	26	13	8
500	27	13	8
> 1,000	28	13	8



**Figure 45. Graph. Minimum number of tendons required to detect at least one tendon with deficient grout assuming 5 percent of the samples are defective.**

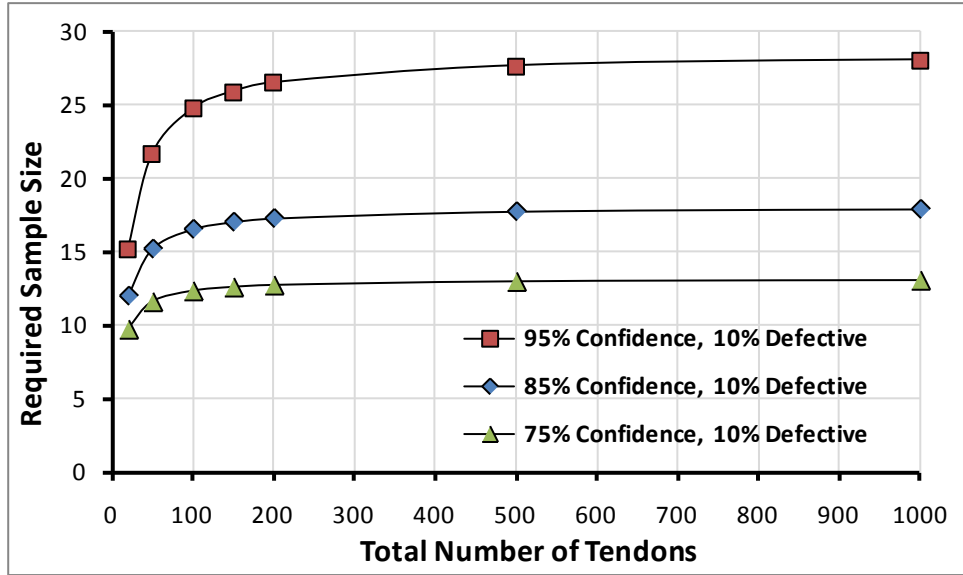


Figure 46. Graph. Minimum number of tendons required to detect at least one tendon with deficient grout assuming 10 percent of the samples are defective.

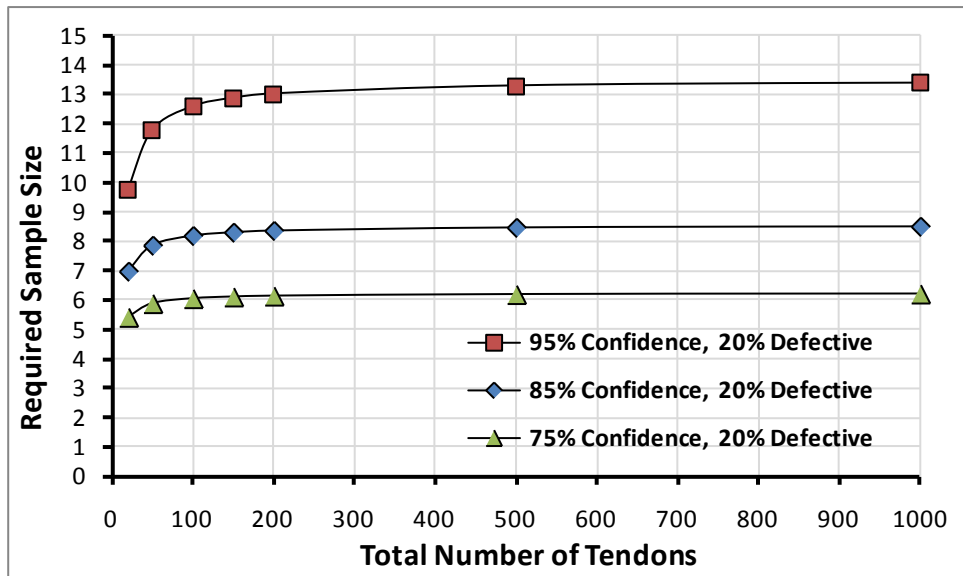
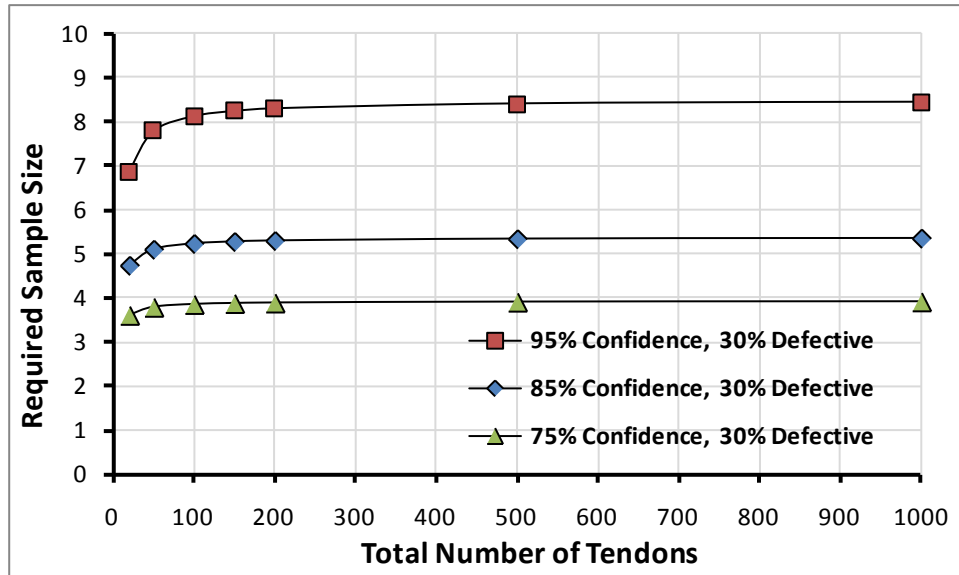


Figure 47. Graph. Minimum number of tendons required to detect at least one tendon with deficient grout assuming 20 percent of the samples are defective.





**Figure 48. Graph. Minimum number of tendons required to detect at least one tendon with deficient grout assuming 30 percent of the samples are defective.**

### Sampling Procedure Summary

The procedure to determine the recommended minimum number of sampled tendons to be tested consists of the following steps:

1. Estimate the total number of tendons for each considered tendon type. Review the as-built plans, PT shop drawings, specifications, and construction records and identify all tendon types. Determine the number of tendons for each considered tendon type.
2. Prioritize the tendons by assigning them to one of three risk categories (high, medium, or low).
3. Determine the probability of defect indicator (see table 1 through table 5) for each considered tendon group.
4. Determine the consequence of failure indicator (see table 6 through table 9) for each considered tendon group.
5. Assign the group to one of the three risk categories as shown in figure 37.
6. Based on the structural impact/distress caused by sampling tendons from each group, use table 10 to determine an acceptable fraction of tendons with undetected deficient grout.
7. Determine the minimum number of sampled tendons. Use table 11 for level 1 inspection (75 percent confidence) and table 12 for level 2 inspection (95 percent confidence).

After the minimum number of sampled tendons to be tested is determined, it is necessary to locate the strategic inspection points for each tendon type (see chapter 7).

The selection of a random sample from the list of identified inspection locations involves the following steps:

1. Assign a random number to each tendon.
2. Sort each tendon according to the order it is numbered.

Note that a predetermined number (percentage) of tendons should be selected starting from the top or bottom of the list of tendon numbers.

## EXAMPLES

### Typical Balanced Cantilever Bridge

The procedure for option 2 inspection is presented in this section as an example using an existing precast segmental bridge. The plans for the considered bridge can be found in appendix A. The bridge consists of 10 spans with the total length of 2,256.33 ft. The following four distinct types of tendons are utilized in this bridge:

- **Cantilever tendons:** Internal longitudinal tendons (12 tendons with 0.6-inch diameter) in the top flange over the piers. The tendons are straight and vary from short to long with small curvature changes.
- **Continuity top and bottom flange internal tendons:** Internal longitudinal tendons (12 tendons with 0.6-inch diameter). The tendons are straight and vary from short to long with small curvature changes.
- **Longitudinal external draped tendons:** Short single-span tendons (12 tendons with 0.6-inch diameter) with large curvature changes/long distance between lowest and highest points.
- **Transverse internal tendons in the top flange:** Short internal tendons (four tendons with 0.6-inch diameter and nine tendons with 0.6-inch diameter) with small curvature changes.

Overall, the bridge is in good condition and has excellent workmanship. It is assumed that construction records are not available or are incomplete. The sampling procedure used in this example is as follows:

1. Estimate the number of the tendons for each tendon type.
  - Total number of cantilever tendons = 242.
  - Total number of continuity top and bottom tendons = 112.
  - Total number of draped tendons = 40.
  - Total number of transverse tendons = 694.

- Prioritize the tendons by assigning them to one of three risk categories.
- Determine the probability of defect indicator (see table 13).

**Table 13. Balanced cantilever bridge—probability of defect indicator.**

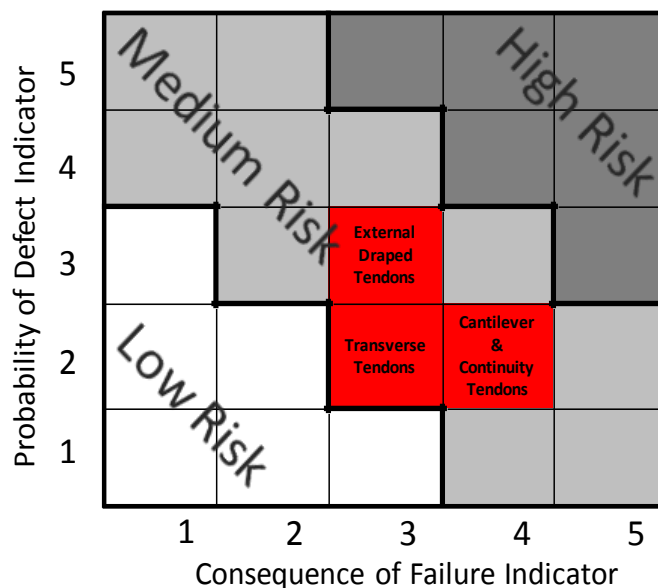
Category	Weight (table 5)	Tendon Type			
		Transverse	Cantilever	Continuity	External
Bridge condition (table 1)	0.15	2	2	2	2
Construction and inspection records (table 2)	0.15	5	5	5	5
Visual inspection (table 3)	0.30	1	1	1	1
Tendon shape and length (table 4)	0.40	1	2	2	4
Probability of defect indicator		2	2	2	3

- Determine consequence of failure indicator (see table 14).

**Table 14. Balanced cantilever bridge—consequence of failure indicator**

Category	Weight (table 9)	Tendon Type			
		Transverse	Cantilever	Continuity	External
Cost of repair or replacement (table 6)	0.40	3	5	4	2
Element/tendon redundancy (table 7)	0.40	2	2	4	2
Bridge importance (table 8)	0.20	5	5	5	5
Consequence of failure indicator		3	4	4	3

- Assign tendon groups to appropriate risk categories (see figure 49).



**Figure 49. Graph. Balanced cantilever bridge—tendon risk categories.**

6. For each identified group, select an acceptable fraction of tendons with undetected deficient grout and determine the minimum number of sampled tendons (see table 15).

**Table 15. Balanced cantilever bridge—minimum recommended number of tendons for inspection.**

Type of Tendon	Total Number of Tendons	Risk	Structural Impact Caused by Inspection	Acceptable Fraction Of Undetected Defective	Minimum Number of Tendons for Inspection	
					Level 1	Level 2
Transverse tendon	694	Medium	High	30 percent	4	8
Cantilever tendon	242	Medium	High	30 percent	4	8
Continuity tendon	112	Medium	Medium	20 percent	6	13
External tendon	40	Medium	Low	10 percent	12	22

7. Randomly select the required number of tendons for each tendon type.

Table 16 through table 19 present the summary of all tendons. Each tendon is identified by its label. The first letter and number denotes the span number “S.” The second letter denotes the tendon name as shown in the as-built plans. The last number helps identify the tendon in case there are two or more tendons with the same profile at one location. All of the data in tables are sorted with respect to the random number assigned to each tendon. Bold text indicates level 1 inspections, and bold italics indicates level 2 inspections.

**Table 16. List of continuity tendons.**

#	Random #	Tendon ID	#	Random #	Tendon ID	#	Random #	Tendon ID	#	Random #	Tendon ID
1	0.022	S7-C4-1	29	0.237	S1-C5-2	57	0.461	S1-C3-1	85	0.783	S8-C1-2
2	0.028	S5-T20-2	30	0.254	S4-T21-2	58	0.462	S2-C3-1	86	0.788	S4-C2-2
3	0.055	S7-C5-1	31	0.258	S4-T20-2	59	0.467	S4-C3-1	87	0.802	S2-C1-1
4	0.055	S7-T20-1	32	0.270	S8-C2-1	60	0.476	S2-T20-2	88	0.806	S5-C4-1
5	0.056	S9-T21-2	33	0.274	S10-C1-2	61	0.504	S3-C2-2	89	0.812	S2-C4-1
6	0.063	S9-C2-1	34	0.282	S2-C2-2	62	0.504	S1-T20-2	90	0.813	S1-C4-1
7	0.078	S5-T20-1	35	0.287	S9-C3-1	63	0.509	S8-C4-2	91	0.818	S6-C2-1
8	0.088	S3-C2-1	36	0.298	S9-C2-2	64	0.521	S7-T20-2	92	0.818	S3-T20-2
9	0.092	S6-C3-1	37	0.328	S7-C2-1	65	0.527	S5-C2-1	93	0.833	S3-C1-1
10	0.098	S5-C3-1	38	0.359	S6-C5-2	66	0.569	S4-C2-1	94	0.835	S3-C6-1
11	0.112	S2-C2-1	39	0.363	S10-C2-1	67	0.573	S1-C2-1	95	0.843	S1-C2-2
12	0.112	S6-C3-2	40	0.364	S6-T20-1	68	0.578	S7-C1-1	96	0.850	S3-C6-2
13	0.114	S5-C5-1	41	0.372	S7-C3-2	69	0.593	S7-C4-2	97	0.855	S6-C1-1
14	0.134	S5-C4-2	42	0.383	S6-T20-2	70	0.605	S1-C4-2	98	0.861	S5-C1-2
15	0.134	S8-C5-2	43	0.389	S7-C1-2	71	0.609	S3-C1-2	99	0.892	S8-C2-2
16	0.147	S7-C3-1	44	0.399	S6-C2-2	72	0.620	S2-C4-2	100	0.895	S10-C2-2
17	0.161	S8-T20-2	45	0.407	S8-C1-1	73	0.640	S1-C5-1	101	0.907	S4-T20-1
18	0.162	S7-C2-2	46	0.414	S5-C3-2	74	0.646	S2-C1-2	102	0.918	S3-T20-1
19	0.176	S4-C1-1	47	0.416	S1-T20-1	75	0.666	S9-C3-2	103	0.920	S4-C3-2
20	0.184	S4-C4-2	48	0.419	S2-T20-1	76	0.692	S8-C3-1	104	0.931	S10-T20-2
21	0.194	S8-C3-2	49	0.424	S1-C3-2	77	0.704	S5-C1-1	105	0.939	S3-C5-2
22	0.195	S3-C3-1	50	0.428	S9-T20-1	78	0.707	S7-C5-2	106	0.942	S1-C1-1
23	0.199	S9-C1-1	51	0.432	S3-C4-1	79	0.707	S5-C2-2	107	0.943	S3-C4-2
24	0.207	S10-C1-1	52	0.441	S6-C4-2	80	0.714	S3-C3-2	108	0.968	S1-C1-2
25	0.219	S9-C1-2	53	0.450	S8-C5-1	81	0.718	S2-C3-2	109	0.970	S8-C4-1
26	0.230	S10-T20-1	54	0.456	S6-C4-1	82	0.737	S4-T21-1	110	0.976	S6-C5-1
27	0.235	S4-C4-1	55	0.459	S4-C1-2	83	0.752	S9-T20-2	111	0.989	S9-T21-1
28	0.236	S6-C1-2	56	0.460	S5-C5-2	84	0.783	S8-T20-1	112	0.998	S3-C5-1

**Table 17. List of external draped tendons.**

#	Random #	Tendon ID	#	Random #	Tendon ID
1	0.001	S10-E1-1	21	0.416	S9-E1-2
2	0.040	S7-E2-1	22	0.453	S4-E1-2
3	0.062	S4-E1-1	23	0.457	S4-E2-2
4	0.064	S10-E2-1	24	0.493	S3-E1-1
5	0.074	S7-E1-1	25	0.600	S4-E2-1
6	0.080	S10-E2-2	26	0.631	S5-E2-1
7	0.090	S9-E2-2	27	0.642	S3-E2-1
8	0.116	S9-E1-1	28	0.645	S8-E2-1
9	0.118	S3-E1-2	29	0.685	S1-E1-1
10	0.119	S8-E2-2	30	0.693	S8-E1-1
11	0.129	S7-E2-2	31	0.783	S1-E2-2
12	0.148	S2-E1-1	32	0.792	S5-E2-2
13	0.161	S3-E2-2	33	0.794	S2-E2-1
14	0.201	S1-E1-2	34	0.894	S10-E1-2
15	0.234	S2-E2-2	35	0.897	S7-E1-2
16	0.243	S5-E1-2	36	0.906	S5-E1-1
17	0.274	S2-E1-2	37	0.909	S9-E2-1
18	0.360	S6-E2-2	38	0.932	S1-E2-1
19	0.362	S6-E1-2	39	0.943	S8-E1-2
20	0.372	S6-E1-1	40	0.974	S6-E2-1

**Table 18. List of selected transverse tendons.**

#	Random #	Tendon ID
1	0.001	249
2	0.001	255
3	0.004	103
4	0.005	388
5	0.006	694
6	0.009	426
7	0.015	456
8	0.020	638

**Table 19. List of cantilever tendons.**

#	Random #	Tendon ID	#	Random #	Tendon ID	#	Random #	Tendon ID	#	Random #	Tendon ID
1	0.016	P3-T11-2	62	0.285	P4-T1-2	123	0.503	P4-T2-2	184	0.741	P5-T3-1
2	0.016	P10-T2-1	63	0.288	P7-T10-1	124	0.504	P4-T2-1	185	0.744	P6-T1-1
3	0.020	P8-T5-2	64	0.291	P9-T3-1	125	0.504	P5-T9-2	186	0.746	P8-T14-2
4	0.022	P7-T9-1	65	0.304	P2-T3-2	126	0.509	P5-T3-2	187	0.759	P5-T7-1
5	0.027	P2-T10-1	66	0.306	P4-T8-2	127	0.511	P8-T10-1	188	0.760	P3-T1-1
6	0.032	P3-T7-1	67	0.307	P2-T8-2	128	0.522	P4-T5-2	189	0.762	P5-T6-2
7	0.038	P6-T2-1	68	0.309	P7-T5-1	129	0.525	P7-T7-2	190	0.763	P10-T4-2
8	0.038	P3-T4-2	69	0.309	P4-T10-1	130	0.528	P8-T10-2	191	0.782	P8-T4-1
9	0.046	P6-T4-2	70	0.309	P3-T8-2	131	0.529	P8-T13-1	192	0.782	P7-T6-2
10	0.049	P3-T5-2	71	0.322	P8-T2-1	132	0.531	P6-T14-2	193	0.789	P10-T2-2
11	0.050	P4-T10-2	72	0.328	P6-T5-1	133	0.533	P4-T16-2	194	0.798	P9-T9-1
12	0.053	P2-T8-1	73	0.343	P8-T7-1	134	0.536	P6-T9-2	195	0.807	P9-T4-1
13	0.055	P10-T1-1	74	0.350	P6-T4-1	135	0.538	P9-T6-2	196	0.808	P6-T8-1
14	0.058	P7-T4-2	75	0.351	P9-T1-1	136	0.540	P6-T13-1	197	0.810	P6-T9-1
15	0.058	P10-T5-1	76	0.353	P10-T6-2	137	0.548	P9-T1-2	198	0.815	P9-T7-2
16	0.059	P2-T5-1	77	0.359	P8-T9-1	138	0.549	P4-T11-2	199	0.836	P3-T10-2
17	0.061	P6-T13-2	78	0.369	P5-T11-2	139	0.552	P5-T10-2	200	0.838	P8-T9-2
18	0.070	P3-T14-1	79	0.377	P3-T10-1	140	0.560	P9-T12-1	201	0.838	P2-T7-2
19	0.074	P6-T8-2	80	0.377	P6-T11-2	141	0.568	P9-T14-1	202	0.844	P7-T13-1
20	0.084	P6-T7-1	81	0.380	P5-T1-1	142	0.568	P8-T3-2	203	0.847	P4-T4-1
21	0.085	P8-T12-2	82	0.380	P8-T14-1	143	0.569	P8-T7-2	204	0.853	P5-T7-2
22	0.089	P4-T7-1	83	0.381	P8-T5-1	144	0.572	P5-T10-1	205	0.858	P7-T13-2
23	0.097	P3-T1-2	84	0.381	P9-T16-2	145	0.578	P9-T5-2	206	0.860	P7-T10-2
24	0.100	P3-T6-1	85	0.389	P9-T8-2	146	0.581	P10-T7-2	207	0.862	P7-T4-1
25	0.104	P9-T5-1	86	0.396	P4-T9-2	147	0.582	P3-T14-2	208	0.865	P6-T5-2
26	0.105	P6-T1-2	87	0.398	P4-T4-2	148	0.586	P10-T3-2	209	0.872	P3-T2-2
27	0.107	P2-T1-2	88	0.398	P5-T4-1	149	0.590	P3-T15-1	210	0.876	P6-T14-1
28	0.109	P9-T12-2	89	0.399	P7-T11-1	150	0.608	P5-T1-2	211	0.878	P3-T15-2
29	0.112	P7-T8-1	90	0.399	P3-T5-1	151	0.609	P3-T9-2	212	0.886	P5-T13-2
30	0.120	P4-T7-2	91	0.400	P2-T5-2	152	0.618	P4-T6-1	213	0.888	P3-T12-2
31	0.134	P10-T4-1	92	0.403	P2-T9-2	153	0.626	P7-T12-2	214	0.889	P5-T11-1
32	0.136	P9-T7-1	93	0.404	P8-T3-1	154	0.627	P6-T7-2	215	0.891	P9-T15-2
33	0.138	P7-T8-2	94	0.405	P9-T15-1	155	0.629	P6-T12-1	216	0.892	P3-T4-1
34	0.146	P2-T6-1	95	0.405	P8-T8-1	156	0.630	P9-T11-2	217	0.894	P9-T10-1
35	0.153	P9-T16-1	96	0.410	P4-T13-1	157	0.630	P7-T2-2	218	0.895	P4-T6-2
36	0.159	P4-T8-1	97	0.412	P10-T1-2	158	0.630	P4-T14-2	219	0.907	P6-T3-1
37	0.162	P7-T9-2	98	0.413	P6-T3-2	159	0.633	P6-T12-2	220	0.925	P3-T13-2
38	0.163	P4-T9-1	99	0.415	P9-T6-1	160	0.633	P9-T13-1	221	0.933	P4-T11-1
39	0.165	P3-T13-1	100	0.416	P6-T6-1	161	0.636	P4-T12-1	222	0.937	P2-T7-1
40	0.165	P3-T16-1	101	0.418	P4-T16-2	162	0.640	P8-T6-1	223	0.940	P9-T13-2
41	0.165	P7-T14-1	102	0.420	P3-T2-1	163	0.644	P8-T11-1	224	0.940	P6-T6-2
42	0.169	P3-T16-2	103	0.435	P10-T6-1	164	0.652	P6-T10-2	225	0.952	P7-T14-2
43	0.182	P6-T10-1	104	0.435	P3-T11-1	165	0.654	P2-T10-2	226	0.962	P8-T1-2
44	0.185	P7-T3-2	105	0.437	P7-T1-1	166	0.659	P2-T1-1	227	0.964	P9-T3-2
45	0.186	P4-T15-2	106	0.441	P7-T2-1	167	0.660	P9-T10-2	228	0.965	P5-T5-2
46	0.189	P5-T4-2	107	0.446	P9-T2-1	168	0.664	P7-T12-1	229	0.967	P4-T3-1
47	0.194	P10-T8-2	108	0.447	P4-T3-2	169	0.668	P6-T2-2	230	0.968	P7-T5-2
48	0.207	P3-T3-2	109	0.449	P2-T2-1	170	0.669	P9-T9-2	231	0.969	P8-T4-2

49	0.210	P8-T8-2	110	0.452	P8-T1-1	171	0.669	P10-T8-1	232	0.971	P2-T2-2
50	0.221	P3-T8-1	111	0.466	P3-T3-1	172	0.671	P5-T12-1	233	0.971	P6-T11-1
51	0.228	P9-T11-1	112	0.471	P4-T5-1	173	0.671	P2-T6-2	234	0.974	P5-T5-1
52	0.234	P4-T13-2	113	0.472	P7-T7-1	174	0.677	P5-T2-2	235	0.975	P4-T15-2
53	0.250	P10-T5-2	114	0.479	P3-T7-2	175	0.699	P3-T12-1	236	0.976	P9-T14-2
54	0.252	P5-T9-1	115	0.480	P4-T1-1	176	0.708	P2-T3-1	237	0.979	P8-T13-2
55	0.254	P7-T3-1	116	0.482	P4-T14-2	177	0.713	P8-T12-1	238	0.979	P3-T9-1
56	0.256	P7-T11-2	117	0.487	P5-T12-2	178	0.720	P7-T1-2	239	0.982	P10-T3-1
57	0.258	P5-T6-1	118	0.488	P5-T13-1	179	0.726	P9-T2-2	240	0.984	P8-T2-2
58	0.261	P8-T6-2	119	0.489	P2-T9-1	180	0.727	P2-T4-1	241	0.990	P4-T12-2
59	0.262	P5-T2-1	120	0.493	P9-T4-2	181	0.728	P3-T6-2	242	0.992	P5-T8-2
60	0.265	P10-T7-1	121	0.495	P8-T11-2	182	0.729	P9-T8-1	235	0.975	P4-T15-2
61	0.277	P5-T8-1	122	0.500	P7-T6-1	183	0.737	P2-T4-2			

### Typical Spliced Girder Bridge

In a second example, a typical existing spliced girder bridge was used with a 3-span configuration (main channel unit) as part of a 24-span bridge for a total length of 3,585 ft. The approaches were constructed with eight lines of Florida bulb-T78 precast prestressed concrete girders. The main channel unit is continuous over three spans that are  $196.6 \times 250 \times 196.6$  ft. It was constructed with eight lines of modified Florida bulb-T78 girders. Each girder line consists of two haunched pier segments, a main span drop-in segment, and two side span drop-in segments. Each segment is an individually precast pretensioned girder that supports its own weight and handling loads. All segments in one line of girder are continuously PT with four 15-internal draped tendons with 0.6-inch diameter from end to end. The haunch segment diaphragms are transversely PT with three tendons at each diaphragm. The plans can be viewed in appendix B.

The bridge is in good condition but has less than desirable workmanship based on visual inspection. The complete construction and inspection records are not available. The considered structure is a typical highway bridge carrying medium traffic volumes. It is assumed that the owner performed an option 2 inspection. The sampling procedure used in this example is as follows:

1. Estimate the number of the tendons for each tendon type.
  - Total number of longitudinal draped tendons = 32.
  - Total number of pier cap transverse PT = 16.
  - Total number of diaphragm transverse PT = 6.
2. Prioritize the tendons by assigning them to one of three risk categories.
3. Determine the probability of defect indicator (see table 20).



**Table 20. Spliced girder bridge—probability of defect indicator.**

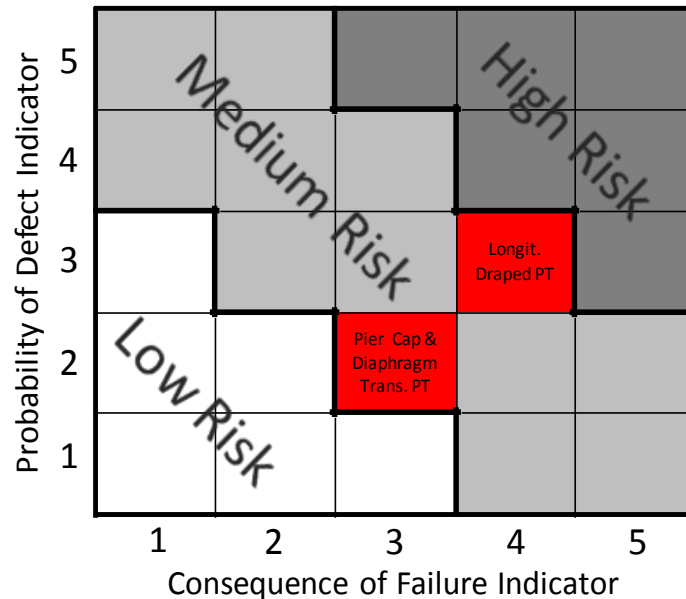
Category	Weight (table 5)	Tendon Type		
		Longitudinal Draped	Pier Cap Transverse	Diaphragm Transverse
Bridge condition (table 1)	0.15	3	3	3
Construction and inspection records (table 2)	0.15	4	4	4
Visual inspection (table 3)	0.30	1	1	1
Tendon shape and length (table 4)	0.40	5	2	1
Probability of defect indicator		3	2	2

4. Determine the consequence of failure indicator (see table 21).

**Table 21. Spliced girder bridge—consequence of failure indicator.**

Category	Weight (table 9)	Tendon Type		
		Longitudinal Draped	Pier Cap Transverse	Diaphragm Transverse
Cost of repair or replacement (table 6)	0.40	5	4	3
Element/tendon redundancy (table 7)	0.40	3	2	2
Bridge importance (table 8)	0.20	3	3	3
Consequence of failure indicator		4	3	3

5. Assign tendon groups to appropriate risk categories (see figure 50).



**Figure 50. Graph. Spliced girder bridge—tendon risk categories.**

6. For each identified group, select an acceptable fraction of undetected deficient grout locations and determine the minimum number of sampled tendons (see table 22).

**Table 22. Spliced girder bridge—minimum recommended number of tendons for inspection.**

Type of Tendon	Total Number of Tendons	Risk	Structural Impact Caused by Inspection	Acceptable Fraction Of Undetected Defective	Minimum Number of Tendons for Inspection	
					Level 1	Level 2
Longitudinal draped	32	Medium	High	30 percent	4	7
Pier cap transverse	16	Medium	High	30 percent	4	6
Diaphragm transverse	6	Medium	Medium	20 percent	5	6

7. Randomly select the required number of tendons for each tendon type.

Table 23 through table 25 present the summary of all tendons. Each tendon is identified by its label. The first letters and number denote the girder number “G,” pier number “P,” and pier diaphragm number “DP.” The second letter denotes the tendon name “T” as shown in the as-built plans. All of the data are sorted with respect to the random number assigned to each tendon. The required number of tendons is selected from the top of the tendon list and is bold for the level 1 inspections and bold italic for the level 2 inspections.

**Table 23. List of longitudinal draped tendons.**

#	Random #	Tendon ID	#	Random #	Tendon ID
<b>1</b>	<b>0.494</b>	<b>G1-T4</b>	17	0.954	G8-T2
<b>2</b>	<b>0.876</b>	<b>G6-T2</b>	18	0.843	G4-T2
<b>3</b>	<b>0.387</b>	<b>G4-T1</b>	19	0.883	G3-T4
<b>4</b>	<b>0.725</b>	<b>G3-T3</b>	20	0.817	G5-T2
<b>5</b>	<b>0.396</b>	<b>G6-T1</b>	21	0.283	G2-T3
<b>6</b>	<b>0.931</b>	<b>G7-T4</b>	22	0.930	G8-T1
<b>7</b>	<b>0.809</b>	<b>G1-T1</b>	23	0.196	G2-T1
8	0.582	G7-T1	24	0.071	G8-T3
9	0.409	G5-T1	25	0.866	G2-T2
10	0.487	G4-T4	26	0.269	G2-T4
11	0.847	G4-T3	27	0.287	G1-T2
12	0.587	G7-T3	28	0.284	G3-T1
13	0.966	G6-T3	29	0.467	G3-T2
14	0.913	G5-T4	30	0.126	G1-T3
15	0.540	G7-T2	31	0.095	G5-T3
16	0.459	G6-T4	32	0.226	G8-T4

**Table 24. List of diaphragm tendons.**

#	Random #	Tendon ID
1	0.068	DP11-T1
2	0.098	DP10-T2
3	0.414	DP10-T1
4	0.431	DP11-T2
5	0.699	DP10-T3
6	0.884	DP11-T3

**Table 25. List of pier cap tendons.**

#	Random #	Tendon ID
<b>1</b>	<b>0.049</b>	<b>P10-T4</b>
<b>2</b>	<b>0.120</b>	<b>P10-T2</b>
<b>3</b>	<b>0.261</b>	<b>P12-T3</b>
<b>4</b>	<b>0.321</b>	<b>P11-T4</b>
<b>5</b>	<b>0.440</b>	<b>P11-T3</b>
<b>6</b>	<b>0.465</b>	<b>P9-T3</b>
7	0.554	P11-T2
8	0.618	P9-T1
9	0.620	P11-T1
10	0.725	P12-T2
11	0.794	P9-T4
12	0.812	P12-T1
13	0.945	P10-T3
14	0.946	P10-T1
15	0.977	P9-T2
16	0.997	P12-T4

### **Typical Span-by-Span Segmental Bridge**

In the third example, a typical eight-span precast segmental span-by-span bridge construction with a span configuration of  $8 \times 130$  ft is examined. The superstructure consists of a single-cell box girder with 40-ft-wide top deck that is 8 ft deep. There are two types of PT tendons on this bridge as follows:

- **Transverse internal PT:** Four 0.6-inch-diameter strands of transverse tendon at 3-ft spacing.
- **Longitudinal external PT:** 19 0.6-inch-diameter multistrands with 3 pairs of draped tendons per span.

The bridge is in moderate condition and has bad workmanship based on visual inspection. Complete construction and inspection records are available. The bridge carries large volumes of heavy traffic. Option 2 was selected. The sampling procedure used in this example is as follows:

1. Estimate the number of the tendons for each tendon type.
  - Total number of transverse tendons = 347.
  - Total number of external tendons = 48.
2. Prioritize the tendons by assigning them to one of three risk categories.
3. Determine the probability of defect indicator (see table 26).

**Table 26. Span-by-span segmental bridge—probability of defect indicator.**

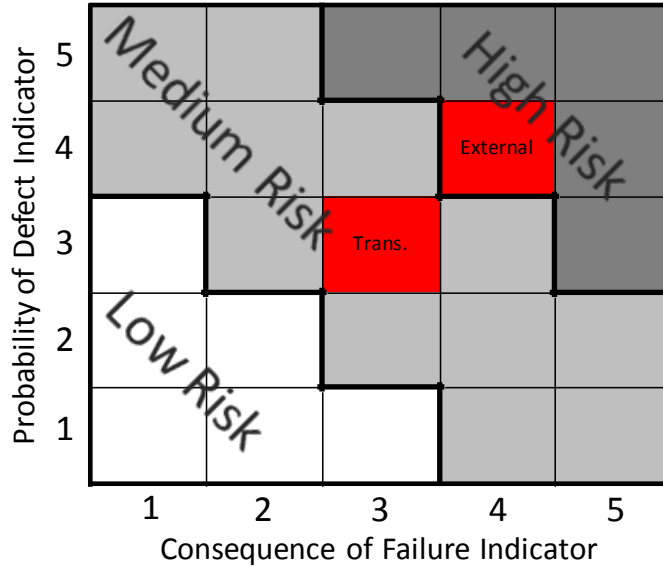
Category	Weight (table 5)	Tendon Type	
		Transverse	External
Bridge condition (table 1)	0.15	4	4
Construction and inspection records (table 2)	0.15	1	1
Visual inspection (table 3)	0.30	5	5
Tendon shape and length (table 4)	0.40	1	4
Probability of defect indicator		3	4

4. Determine the consequence of failure indicator (see table 27).

**Table 27. Span-by-span segmental bridge—consequence of failure indicator.**

Category	Weight (table 9)	Tendon Type	
		Transverse	External
Cost of repair or replacement (table 6)	0.40	2	3
Element/tendon redundancy (table 7)	0.40	2	4
Bridge importance (table 8)	0.20	5	5
Consequence of failure indicator		3	4

5. Assign tendon groups to appropriate risk categories (see figure 51).



**Figure 51. Graph. Span-by-span segmental bridge—tendon risk categories.**

- For each identified group, select an acceptable fraction of undetected deficient grout locations and determine the minimum number of tendons to be sampled (see table 28).

**Table 28. Span-by-span segmental bridge—minimum recommended number of tendons for inspection.**

Type of Tendon	Total Number of Tendons	Risk	Structural Impact Caused by Inspection	Acceptable Fraction Defective	Minimum Number of Tendons for Inspection	
					Level 1	Level 2
Transverse	347	Medium	High	30 percent	4	8
External	48	High	Low	10 percent	12	22

- Randomly select the required number of tendons for each tendon type.

### Typical PT Bridge with Draped Tendons

A five-span continuous bridge with a three-cell box girder superstructure was constructed on a 160-ft-long false-work per span. The bridge was PT with 4 19-strand draped internal tendons with 0.6-inch diameter per web from abutment to abutment. In addition, at each pier the box girder was also PT with top internal tendons and anchored at blisters located at the intersection of web and top deck. The top longitudinal tendons over the exterior web are 3 19-strand tendons with 0.6-inch diameter and 6 19-strand tendons with 0.6-inch diameter over the internal web. The top deck is transversely PT with four 0.6-inch internal tendons at 3-ft spacing. The diaphragm is transverse PT with six 31-strand tendons with 0.6-inch diameter. The diaphragm has ample redundancy due to the large amount of ordinary reinforcing bars. Each diaphragm also has 12 vertical internal PT bars with 1<sup>3</sup>/<sub>8</sub>-inch diameter. The box girder is 7 ft deep. The bridge is in good condition and, it has no defects and average workmanship based on visual inspection. No

construction and inspection records are available. The structure carries large traffic volumes. The procedure is as follows:

1. Estimate the number of the tendons for each tendon type.
  - Total number of top transverse tendons = 267.
  - Total number of top longitudinal tendons = 72.
  - Total number of web longitudinal draped tendons = 16.
  - Total number of transverse diaphragm tendons = 36.
  - Total number of vertical diaphragm PT bars = 72.
2. Prioritize the tendons by assigning them to one of three risk categories.
3. Determine the probability of defect indicator (see table 29).

**Table 29. PT bridge—probability of defect indicator.**

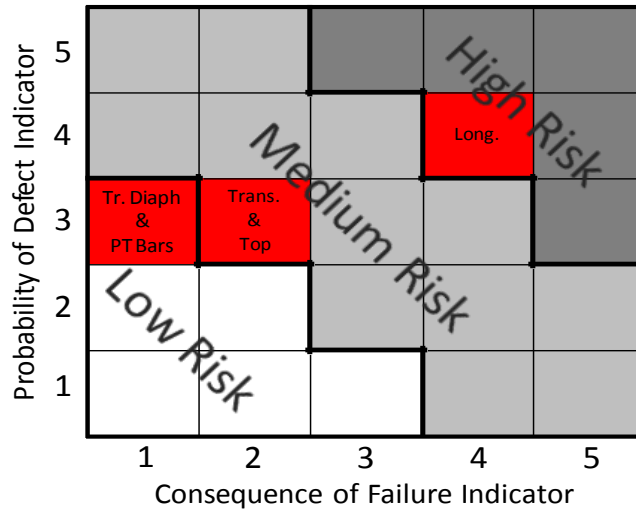
Category	Weight (table 5)	Tendon Type				
		Transverse	Top	Longitudinal	Transverse Diaphragm	PT Bars
Bridge condition (table 1)	0.15	3	3	3	3	3
Construction and inspection records (table 2)	0.15	5	5	5	5	5
Visual inspection (table 3)	0.30	3	3	3	3	3
Tendon shape and length (table 4)	0.40	1	1	5	3	1
Probability of defect indicator		3	3	4	3	3

4. Determine the consequence of failure indicator (see table 30).

**Table 30. PT bridge—consequence of failure indicator.**

Category	Weight (table 9)	Tendon Type				
		Transverse	Top	Longitudinal	Transverse Diaphragm	PT Bars
Cost of repair or replacement (table 6)	0.40	2	2	4	1	1
Element/tendon redundancy (table 7)	0.40	2	2	5	1	1
Bridge importance (table 8)	0.20	3	3	3	3	3
Consequence of failure indicator		2	2	4	1	1

5. Assign tendon groups to appropriate risk categories (see figure 52).



**Figure 52. Graph. PT bridge—tendon risk categories.**

- For each identified group, select an acceptable fraction of undetected deficient grout locations and determine the minimum number of tendons to be sampled (see table 31).

**Table 31. PT bridge—minimum recommended number of tendons for inspection.**

Type of Tendon	Total Number of Tendons	Risk	Structural Impact Caused by Inspection	Acceptable Fraction Defective	Minimum Number of Tendons for Inspection	
					Level 1	Level 2
Transverse tendon	267	Medium	High	30 percent	4	8
Top tendon	72	Medium	High	30 percent	4	8
Longitudinal tendon	16	High	High	20 percent	5	8
Transverse diaphragm tendon	36	Low	High	30 percent	4	7
Vertical diaphragm PT bar	72	Low	High	30 percent	4	8

- Randomly select the required number of tendons for each tendon type.

## CHAPTER 6. GROUT SAMPLING AND TEST METHODS

### GENERAL CONSIDERATIONS

Material (grout in the present case) characterization requires that both composition and structure (macro and micro) be determined. Composition is determined by wet chemistry and analytical techniques such as ion chromatography, X-ray fluorescence, and energy dispersive spectroscopy (EDS), while structure is determined by petrographic methodologies, electron microscopy, and X-ray diffraction.

As an initial step in the case of external tendons, the general appearance of the tendon should be documented. The duct should be inspected for any cracks or connections that could serve as conduits for corrosives from an external source. Access to grout and strands can be accomplished either by end cap removal or by sectioning away duct at an intermediate location along the tendon. In the latter case, duct wall thickness is determined from construction documents, and duct sectioning can be performed using either a plastic cutting wheel or a depth guard that limits grinding depth to that of the duct wall thickness. Caution should be used in duct sectioning so that strands are not impacted. It is important to recognize that these strands may press against the interior duct wall at some circumferential orientation. Upon exposing the grout, its visual appearance and presence of any strand corrosion (or lack thereof) should be documented. Direct access to strands may require removal of some grout cover, which is described later in this chapter. Alternatively, potential measurements can be made to assess the corrosion state of embedded strand. Figure 53 shows a dial depth gauge being used to measure the size of a grout air void at the top of a tendon at a location where access to the underlying grout was made on an external tendon.



Source: Concorr Florida

**Figure 53. Photo. Dial gauge used to determine the depth of a grout air void.**



Internal tendons represent special challenges because intermediate locations along the length require concrete excavation, and there is greater potential that damage to the tendon may occur compared to external tendons. Similar to external tendons, the investigation should document the initial general appearance of internal tendon end caps. An appropriate number of these end caps (see chapter 5) should be opened, and their condition should be assessed. Figure 54 shows a grout sample being taken at an opened internal tendon end by chipping after the cap was removed. Note the plastic sheet beneath the anchorage to ensure no sample contamination. If the grout condition within these is good and grout  $\text{Cl}^-$  analysis results determine that concentration of this species is within acceptable limits, then no further sampling at intermediate locations should be required. However, if the grout appearance is problematic (i.e., undesirable grout types are encountered, see chapter 4),  $\text{Cl}^-$  contaminated, or otherwise defective, then consideration must be given to inspect and sample additional end caps, intermediate locations, or both. This access should be performed by standard concrete excavation methods but with due diligence being taken to ensure that reinforcement is not cut or otherwise compromised and the tendon itself is not damaged. Figure 55 shows concrete excavation to access an internal tendon subsequent to its being located using ground penetrating radar (GPR). Once the tendon is exposed, then inspection and analysis can be performed the same as for external tendons.



Source: Parsons Brinckerhoff

**Figure 54. Photo. Grout sample acquisition at an opened internal tendon end cap by light chipping.**



Source: Concorr Florida

**Figure 55. Photo. Concrete excavation to expose an internal tendon.**

If a grout sample has been acquired from an end cap, then it is probably not necessary to acquire additional samples from the same tendon. However, it may be appropriate to determine the grout quality at intermediate locations, particularly the presence of any air pockets at high points. This can be done for internal tendons with minimal concrete and tendon disruption by drilling with a 1-inch-diameter bit, as shown in figure 56. There are noticeable changes in the drill noise and vibration when a tendon is contacted, which helps ensure that there is no strand damage. If an air pocket is disclosed, it can be inspected using a borescope.



Source: Parsons Brinckerhoff

**Figure 56. Photo. Internal tendon access at an intermediate location by drilling.**

If it is necessary to acquire grout samples at intermediate locations on internal tendons, relatively small excavations can be used, as shown in figure 57. In the figure, an approximately 6-inch-diameter access was created to reveal the exposed strand and grout.



Source: Parsons Brinckerhoff

**Figure 57. Photo. Access hole in an internal tendon at an intermediate location revealing strand and grout.**

Prior to opening a tendon end cap or duct at an intermediate location (external or internal), preparations should be made to capture a sample of any free water that might be present and otherwise lost. This involves placing an opened bag or sealable plastic container beneath the location(s) of anticipated runout.

Particular attention should be given to the following:

- Presence of any air pocket or void space along the top of the duct. Figure 58 shows an interior tendon void space. If defects are present, then components in the air space (the duct internal surface if access is at an intermediate location along the tendon or anchorage end plate and strand ends) should be inspected to determine if grout residue is present. Absence of residue is an indication of incomplete grout filling at the time of construction, while presence of residue may indicate grout subsidence.
- Presence of free water.
- Presence and extent of any corrosion on strands and anchorage.
- Differences in grout color, consistency, or segregation (or a combination of these).
- Presence of voids in the grout (this should be documented for each type of grout appearance).



Source: Parsons Brinckerhoff

**Figure 58. Photo. View of a duct interior revealing a channel air void.**

The following should be collected and deposited in a clean freezer bag using a clean tool such as a flat blade screw driver, chisel, or chipping or a light duty power tool:

- Water sample (if present).
- Corrosion products (if present and accessible).
- Samples of each grout type that is present.
- Any other material that may prove to be of interest.

Samples should be collected as soon as practical after exposing the tendon interior since air exposure may alter composition and structure of the grout and of any corrosion products and free water that may be present. Individuals performing this work should wear clean plastic or rubber gloves to prevent contamination. In cases where the duct opening is at an intermediate position along a tendon and strands are found to have pressed against the duct interior surface, grout sample acquisition should be at the diametrical orientation where strands should have greatest cover. If corroding strands are present in void space, they should be examined using a borescope, either behind the anchor plate if access is at a tendon end or further along the tendon beyond the length where duct was removed at an intermediate location.

### **Sample Size**

A minimum of 75 g of solid sample (this may consist of more than one piece) of each grout type should be obtained and designated by number/letter according to location. While powder can be used for chemical analyses, a solid sample is required for petrography. If soft, wet grout is found, then at least one sample should be placed in a bag and sealed in such a manner that as much air as possible is expelled and that enough pressure is exerted on the grout such that free water is separated. The grout itself should then be removed and placed in a separate bag, and the free water should be retained in the original bag for compositional analysis. Also, as noted in chapter 4, soluble ions have been reported to migrate upward through the grout as it hardens.<sup>(1,22)</sup> Consequently, concentration of these may be greater in the upper regions of the grout. This possibility should be taken into account when acquiring samples.

### **Analyses**

The following techniques are available for compositional determinations:

- X-ray fluorescence (solid or powdered samples only).
- EDS (solid or powdered samples only).
- Ion chromatography (solution only).
- Wet chemistry analysis for total  $\text{Cl}^-$ .<sup>(40)</sup>
- Wet chemistry analysis for soluble  $\text{Cl}^-$ .<sup>(40)</sup>

Standard analysis methods to determine both acid and water soluble  $\text{Cl}^-$  are available. The former (acid soluble) represents the concentration that dissolves in nitric acid and is sometimes referred to as the “total” concentration of  $\text{Cl}^-$  considering that virtually all  $\text{Cl}^-$  is soluble. The latter (water soluble) is the  $\text{Cl}^-$  concentration that is dissolvable in water, which is invariably less than for acid soluble, reflecting the fact that some  $\text{Cl}^-$  is chemically bound by or absorbed on the cement calcium silicate hydrates. An upper limit of 0.08 wt percent cement acid soluble  $\text{Cl}^-$  has been defined for PT grout by multiple specifications and guides; however, several publications also list an upper limit for water soluble  $\text{Cl}^-$  as 0.06 wt percent cement. (See references 5–8.) It is recommended to determine the acid soluble  $\text{Cl}^-$  concentration since the possibility exists that  $\text{Cl}^-$  that is bound at one time may later become free and facilitate corrosion.

As a minimum, X-ray fluorescence and wet chemistry analysis should be performed. Components for which determinations should be made are  $\text{Cl}^-$ ,  $\text{SO}_4^{2-}$ ,  $\text{K}^+$ , and  $\text{Na}^+$ ,  $\text{Cl}^-$ , and  $\text{SO}_4^{2-}$  are determinants of loss of passivity and onset of active corrosion, and  $\text{K}^+$  and  $\text{Na}^+$  are determinants of cement alkalinity. Any free water samples should be analyzed by ion chromatography. Estimating grout  $\text{Cl}^-$  concentrations on site in real time can be accomplished using the Germann Instruments (GI) Rapid Chloride Test (RCT) test kit for acid soluble  $\text{Cl}^-$ . The procedure requires a 5-g powdered sample and takes about 10–15 min to perform. A test kit for determining water soluble  $\text{Cl}^-$  concentration (GI RCT water) is also available; however, the test for acid soluble  $\text{Cl}^-$  is recommended.

Petrographic analysis should be performed in accordance with the applicable ASTM standard.<sup>(41)</sup> Researchers should also include an analysis and explanation of any grout color and consistency distinctions and lack of set. All analyses should be performed by the resident State transportation department or by a transportation department certified laboratory.

Additionally, an option is available to assess corrosion state and rate for strands embedded in grout. Corrosion state is determined by measuring potential. The methodology and data interpretation are described for conventional reinforcing steel in concrete in “Standard Practice for Calculation of Corrosion Rate and Related Information from Electrochemical Measurements.”<sup>(42)</sup> Corrosion rate is determined by measuring polarization resistance from which corrosion rate can be calculated.<sup>(43,44)</sup> Both techniques require a standard reference electrode, a high impedance voltmeter, access to grout in the vicinity where the strands of interest are embedded, and an electrical connection to one or more strands. In addition, polarization resistance measurements require an external (counter) electrode in contact with the grout and a means for imposing small potential changes on the strands via the counter electrode. Because surface area of the strands is likely not known, corrosion rate determinations are qualitative in nature. Lau et al. reported results using both measurement procedures on opened PT tendons.<sup>(22)</sup> The procedures should only be employed by people familiar with the technologies, equipment, and methods.

## **Tools, Equipment, and Instrumentation**

The following lists contain needed information, equipment, and instrumentation for the respective categories.

Background information (as available) includes the following:

- As-built plans.
- Construction documents.
- Previous inspection reports.
- PT shop drawings.
- Grouting plan and log.

Equipment for concrete excavation and strand/grout access includes the following:

- Generator with power cord(s).
- Ventilation fan(s).
- Lighting.
- Standard tool box.
- Rotary hammer.
- Electric drill.
- Small grinder.
- Steel core drill for end cap removal.

Items for sample acquisition include the following:

- Plastic bags.
- Sealable plastic containers.
- High-performance waterproof tape.
- Lightweight power and manual chipping tools and hammer.
- Clean rubber gloves.
- GI RCT test kit if onsite  $\text{Cl}^-$  is intended.

Items for tendon inspection include the following:

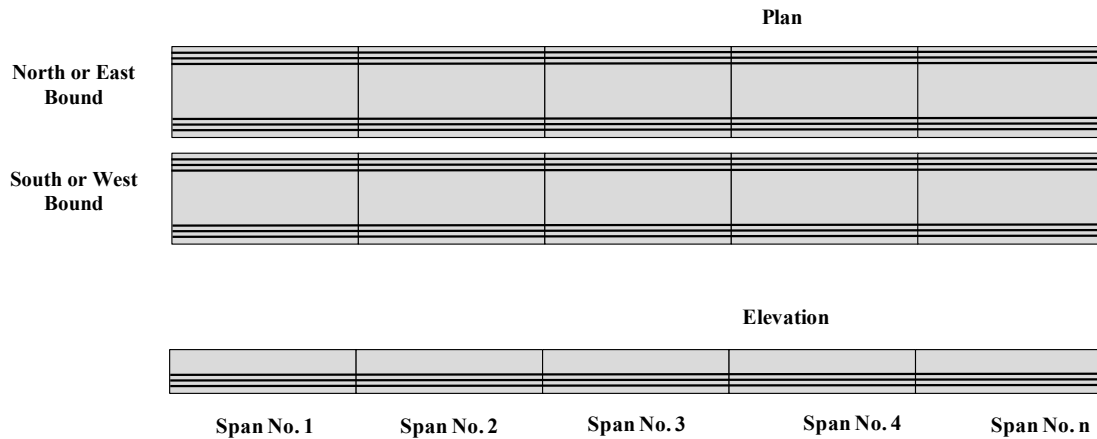
- Digital camera.
- GPR.
- Borescope.

Instrumentation for strand corrosion assessment includes the following:

- Reference electrode with  $\text{Cl}^-$  free soap solution, sponge, and lead wires.
- High-impedance multimeter.
- Polarization resistance instrumentation.

### Reporting

It is recommended that a common data collection and reporting format be employed by the transportation departments conducting grout sampling programs. Figure 59 shows a simplified bridge schematic where three horizontal PT tendons are in place on each side of the box segments. This allows for the identification and representation of grout sampling locations. Likewise, figure 60 provides a format for documenting individual grout samples, and figure 61 illustrates a tabular form for presenting data and analysis results.



**Figure 59. Illustration. Bridge representation used to identify grout sampling locations.**





Bridge Designation:											
Tendon Designation	Sample Number	Grout Type*	Grout Analysis Results, wt% grout				Free Water Analysis Results, wt% sample				Petrographic Analysis Summary
			Cl <sup>-</sup>	SO <sub>4</sub> <sup>2-</sup>	K <sup>+</sup>	Na <sup>+</sup>	Cl <sup>-</sup>	SO <sub>4</sub> <sup>2-</sup>	K <sup>+</sup>	Na <sup>+</sup>	
		1									
		2									
		3									
		4									
		Air Pocket	-								
		*Type 1. Segregated wet, plastic (soft) grout with a clay-like consistency. Type 2. Segregated grout with black, striated layers. Type 3. Segregated grout with a chalky, white consistency. Type 4. Hardened, gray in appearance grout.									
General Description/Remarks of Opened End Cap/Duct											

Figure 61. Illustration. Chart used to record and present analysis results for individual grout samples.



## CHAPTER 7. STRATEGIC SAMPLING LOCATIONS

### BACKGROUND

After the number of sampled tendons are determined based on the methodology presented in chapter 5, it is important to strategically locate the sampling areas in a certain type of tendon after the target tendons are selected. The target tendons should be randomly selected from the bridge being inspected. It is not always possible to remove grout samples from a cut window in the duct away from the anchorages of an internal tendon due to the strand configuration in the duct. If the tendon has a permanent grout cap over the anchor head, the simplest way to collect grout samples is from the cap internal area as shown in figure 62 and figure 63. Extracting grout samples from the grout cap should be used as the first option.



Source: Parsons Brinckerhoff

**Figure 62. Photo. Removing a permanent grout cap.**



Source: Parsons Brinckerhoff

**Figure 63. Photo. Exposed anchor head after grout sampling.**

Grout voids are typically formed by bleed water or trapped air during pumping of the grout. Bleed water tends to move upward in a tendon while transporting chemical compounds such as  $Cl^-$ , which is a similar trend with trapped air. However, trapped air can be anywhere along the tendon. Therefore, typical grout CDs and PDs can be found at the high elevation of the tendon.

This chapter provides a guideline on locating the strategic locations along each type of tendon, also known as the inspection point. In terms of internal tendons, prior to opening a hole in the tendon, the tendon should be located using GPR as shown in figure 64. It is not recommended to use as-built plans to locate internal tendons because tendon locations might change during construction.

For both options 1 and 2 inspections, at least one grout sample per tendon should be selected from the preselected tendons determined in chapter 5.



Source: Parsons Brinckerhoff

**Figure 64. Photo. Locating internal tendons in the web wall using GPR.**

## **BALANCED CANTILEVER BRIDGE**

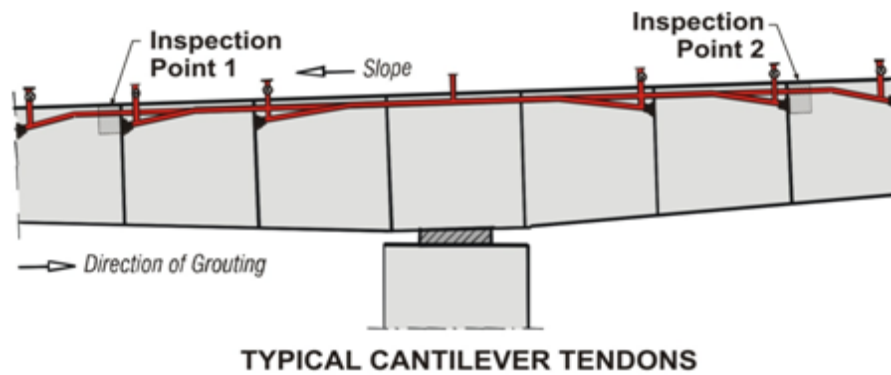
### **Continuity Tendon (Internal Tendon in the Bottom Flange)**

If a permanent grout cap is accessible or exists, the cap should be removed from the blister (see figure 62 and figure 63). Alternatively, the cap can be partially removed using a core drill about 3–4 inches in diameter toward the upper location, as shown in figure 65. The cored section should be saved for later for grout cap repair. The grout sample should be removed as required in chapter 6 for further testing, and its physical condition should be inspected, including the exposed strands in the anchor head and the presence of voids. If the grout cap is not available/accessible or if a void is present in the grout cap, the trumpet interior should be inspected by drilling through a grout port over the trumpet area. This drilling has to be done with extreme care to avoid damage to any strand in the trumpet. If a void is present, a videoscope should be used to inspect the condition of the internal void area. For each continuity tendon selected randomly, both ends of the anchorage should be inspected as shown in figure 66 and figure 67. If severe corrosion is discovered, the entire grout cap and grout over the anchor head should be removed for further investigation.



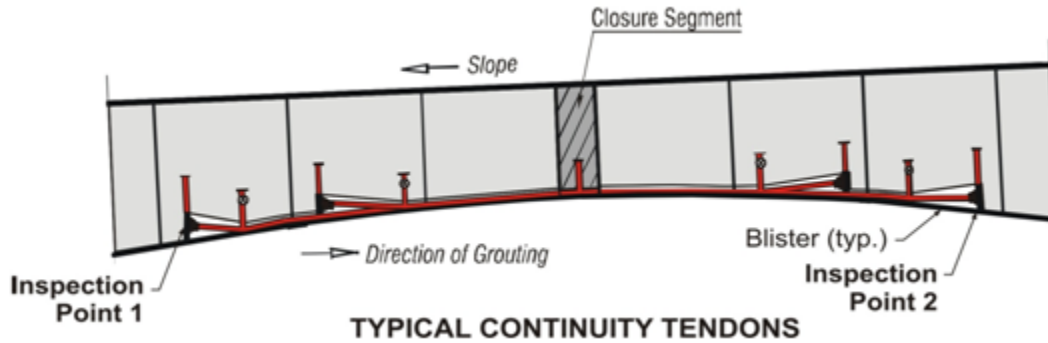
Source: Parsons Brinckerhoff

**Figure 65. Photo. Partial removal of a grout cap.**



Source: Parsons Brinckerhoff

**Figure 66. Illustration. Typical cantilever tendon inspection point locations.**



Source: Parsons Brinckerhoff

**Figure 67. Illustration. Typical continuity tendon inspection point locations.**

After grout sampling and inspection are complete, the grout cap should be restored according to the procedure provided in chapter 8.

In some bridges, no permanent grout cap was installed, and the anchor heads are protected by concrete pour-back. As a result, grout samples cannot be obtained from the anchor head areas. It is recommended to remove grout samples from internal ducts at the end of the blister by chipping concrete over the duct. If grout cap inspection cannot be done, workers should drill through the trumpet and check the condition of the grout in the anchorage.

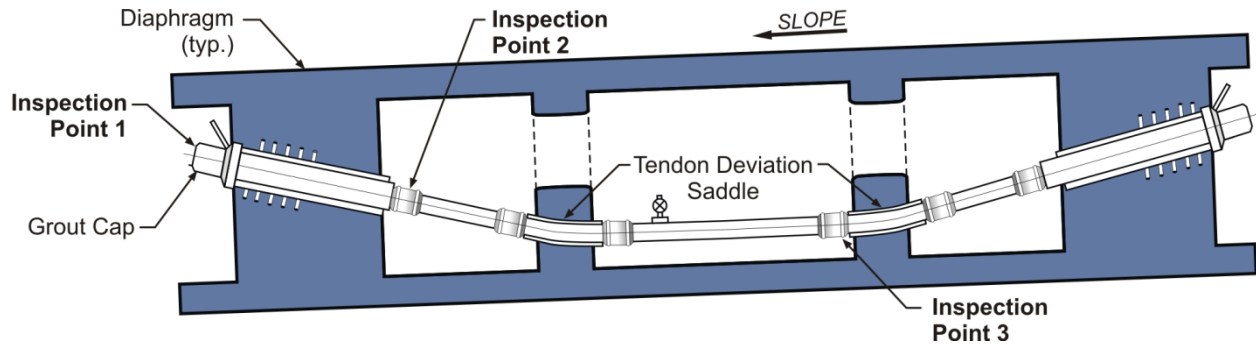
### **Cantilever Tendon (Internal)**

The simplest way to access the cantilever tendon is from the top deck. Because maintenance of traffic is required, it is recommended to access this tendon at night. After the tendon is identified, a chipping gun should be used to remove concrete in the PT block-out a minimum 1 × 2 ft in plan view or larger if necessary. If permanent grout cap is present, a core drill should be used to remove about 3- to 4-inch-diameter specimen of grout cap front face toward an upper location. For a cantilever tendon, at least two inspection points are required, as shown in figure 66 and figure 67.

### **PRECAST SEGMENTAL SPAN-BY-SPAN BRIDGE**

The majority of span-by-span segmental bridge construction consists of external tendons as shown in figure 68. The typical external tendon profile is designed as inclined tendon anchored at both diaphragms of a particular span and draped down at one or two deviators in the bottom flange. For each tendon, a minimum of three inspection points are recommended for grout sampling and investigation. The first point is at the grout cap at the diaphragm, the second point is at the top duct coupler adjacent to the diaphragm, and the third point is at the lower duct coupler close to a deviator.



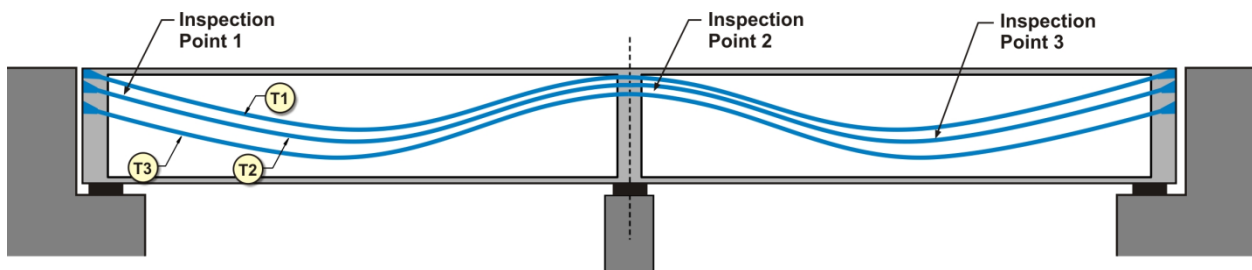


Source: Parsons Brinckerhoff

**Figure 68. Illustration. Typical span-by-span bridge external tendon inspection point locations.**

### CIP PT BRIDGE

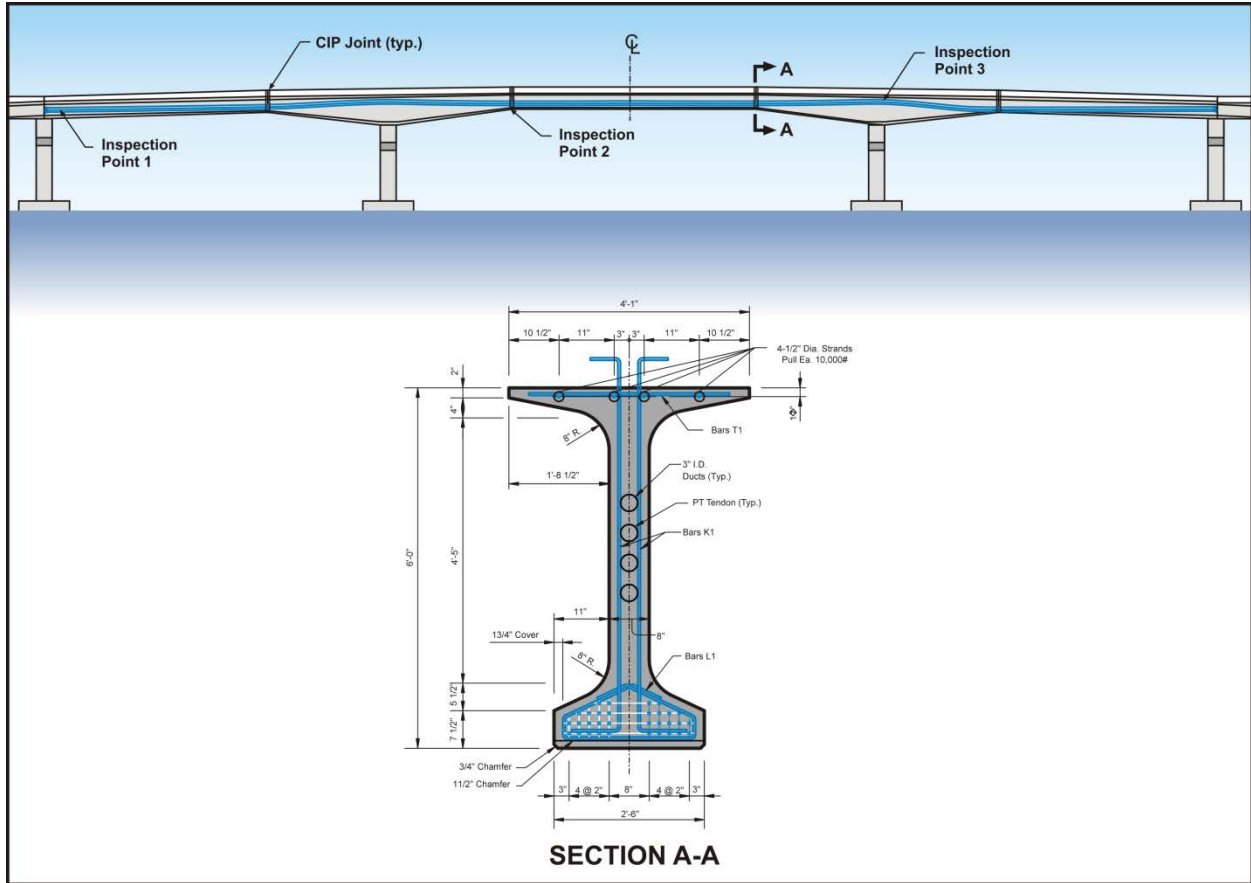
The CIP box girder bridge typically has draped internal tendons in the webs (see figure 69). It is not always possible to access the end anchorages in the end diaphragms. However, it is feasible to probe the tendon from inside the box girder close to the anchorages. For a typical two-span continuous bridge, at least three inspection points should be selected—the first point adjacent to the anchorages, the second point at a high point, and the third point at the lowest point of the tendon. For multiple continuous span bridges with more than two spans, additional inspection points may be required.



**Figure 69. Illustration. CIP PT bridge inspection point locations.**

### SPLICED GIRDER BRIDGE

A PT spliced girder bridge typically has three to four internal tendons from end to end of a multispan continuous unit as shown in figure 70, figure 71 for bulb-tee girders, and figure 72 for a U-girder bridge. Similar to a CIP PT bridge, it is almost impossible to access the anchorage area due to a lack of sufficient clearance at the bridge ends. For a three-span continuous bridge, it is recommended to have a minimum of three inspection points—the first adjacent to the anchorages, the second at the CIP closure joint near the pier, and the third at the highest area over the pier (see figure 70 and figure 72).



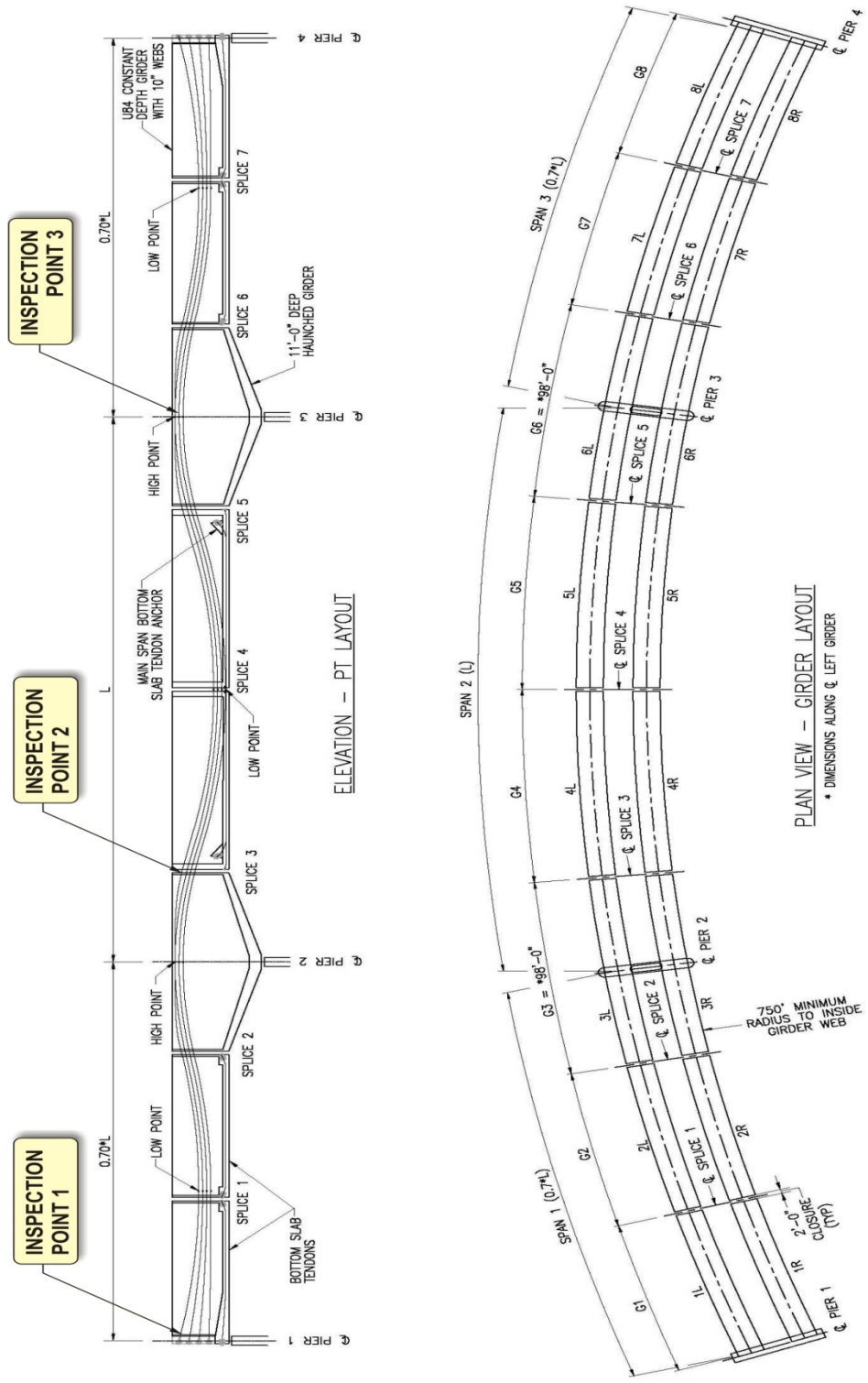
Source: Parsons Brinckerhoff

**Figure 70. Illustration. Spliced bulb-tee girder bridge inspection point locations.**



Source: Parsons Brinckerhoff

**Figure 71. Photo. Spliced bulb-tee girder bridge CIP joint detail.**



Source: Summit Engineering Group

**Figure 72. Illustration. Spliced U-girder bridge inspection locations.**

## CHAPTER 8. RESTORATION METHODS

### GENERAL

Restoration of the tendon damage as a result of inspection and grout sample collection is one of the most important activities in grout sampling. Improper repair/restoration will provide a future path for corrosive agents to the PT system and can compromise long-term durability. Two types of restorations can be performed after inspection and grout sample collection are completed: temporary restoration and permanent restoration.

Temporary restoration should be performed for the following reasons:

- The ambient temperature is too cold.
- There is insufficient restoration material or lack of proper equipment to perform permanent restoration.
- There are unexpected findings that require further investigation (i.e., severe strand corrosion, soft grout, etc.).
- There is a large void in the duct or trumpet finding that requires vacuum grouting for permanent restoration.

Temporary restoration should be able to protect the tendon systems from future corrosive agent intrusion for a maximum of 3 to 6 months before permanent restoration can be conducted. For bridges located in corrosive environments, permanent repair should be done as soon as possible. This requirement on how soon the permanent repair should be done can be adjusted by the local authority based on the conditions and requirements for each project.

An exposed open tendon should not be left for more than 4 h without proper temporary protection. Each day before leaving the project site, all areas of exposed tendons should receive a temporary protection prior to applying temporary restoration or permanent restoration. At minimum, waterproof tapes and plastic covers should be applied. If possible, permanent restoration of the corrosion protection should be performed on the same day as the inspection. The inspection team should provide a consistent and visible color marking at the inspection points based on the approved work plan (prior to the inspection) so that the client/owner of the bridge can keep track of what has been done for future maintenance activities. The industry repair standard practice should be adopted with owners' approval, including the material ingredients, mixture proportions, mixing, placing, and curing method. The restoration material and methods should be included in the work plan and approved by the owners prior to onsite construction restoration.

## TEMPORARY RESTORATION

### External Tendon

The procedure for temporary restoration of external tendons is as follows:

1. Properly clean any dust and soft material in the restoration area using vacuum cleaner or dry air blower.
2. Apply an approved hydraulic cement grout mortar over any exposed strands.
3. Reattach the original two half pieces of polyethylene (PE) ducts (two half duct).
4. Seal the cut lines with sealant.
5. Wrap the restoration area with a minimum 4 inches of high-performance waterproof tapes at each end (see figure 73).



Source: Concorr Florida

**Figure 73. Photo. Temporary restoration of an external tendon.**

## **Internal Tendon**

The procedure for temporary restoration of internal tendons is as follows:

1. Properly clean any dust and soft material in the restoration area using a vacuum cleaner.
2. Apply an approved hydraulic cement grout mortar over any exposed strands.
3. For a metal duct, bend the duct back covering the mortar.
4. Apply hydraulic cement mortar over the duct/magnesium ammonium phosphate concrete (MAPC) to the concrete surface.

## **PERMANENT RESTORATION**

### **External Tendon**

The procedure for permanent restoration of external tendons is as follows:

1. Properly clean any dust and soft material in the restoration area by vacuum cleaner or dry air blower.
2. Apply an approved hydraulic cement grout mortar over any exposed strands.
3. Reattach the original two half pieces of PE ducts.
4. Seal the cut lines with sealant.
5. Wrap the restoration area with a minimum of 4 inches of heat shrink wrap at each end (see figure 74).



Source: Concorr Florida

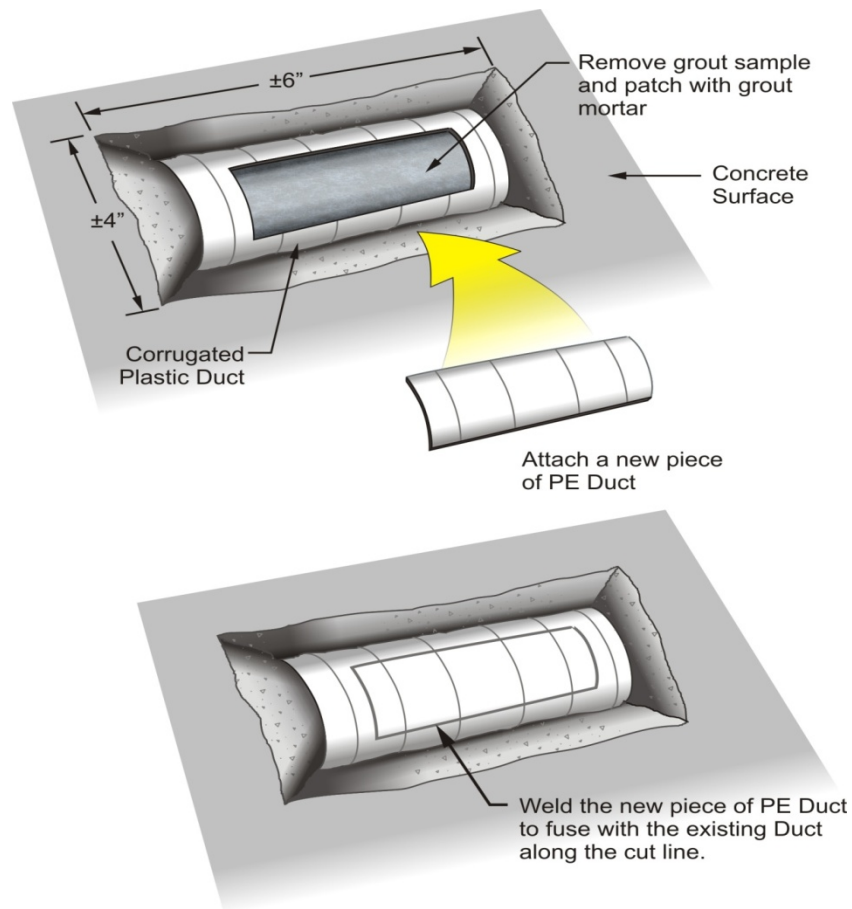
**Figure 74. Photo. Permanent restoration of an external tendon using heat shrink sleeve.**

## Internal Tendon

The procedure for permanent restoration of internal tendons is as follows:

1. Properly clean any dust and soft material in the restoration area using a vacuum cleaner.
2. Remove part of metal or plastic ducts.
3. Apply an approved hydraulic cement grout mortar over any exposed strands.
4. For plastic duct, cover the grout mortar with a piece of new plastic duct of the same dimensions with the opening. Weld the new plastic section with the existing duct around the cut perimeter and apply epoxy over the perimeter of the cut (see figure 75).
5. Patch hydraulic cement mortar/MAPC over the restored duct to the concrete surface.

Note that it is not necessary to remove concrete all around the duct since this will cause more damage to the structure and will be more difficult to restore.



*NOTE: Reinforcing bars are not shown for clarity.*

**Figure 75. Illustration. Permanent restoration of an internal tendon duct.**

## Grout Cap

The procedure for permanent restoration of grout caps is as follows:

1. For an existing bridge with no grout cap or if the grout cap has been damaged during removal, install a new grout cap for permanent restoration.
2. If a grout sample is removed from the anchor head, patch the area of the missing grout with an approved hydraulic cement grout mortar prior to reinstalling the grout cap. In cases where the whole grout is removed, regrout the cap cavity by gravity feed after the cap is installed.
3. For a partially cored grout cap, patch the area of the grout taken for a sample with grout mortar and the original cored piece reinstalled. Seal the perimeter of the piece with epoxy (see figure 76).
4. Reapply the elastomeric coating over the cap.
5. For cantilever or other tendons with a pour-back present, restore the pour-back with epoxy concrete.

Figure 76 through figure 78 show the permanent restoration process of a grout cap, including elastomeric coat application.



Source: Parsons Brinckerhoff

**Figure 76. Photo. Completed restoration of a partially cut grout cap prior to coating.**





Source: Parsons Brinckerhoff

**Figure 77. Photo. Applying elastomeric coating over a grout cap.**



Source: Parsons Brinckerhoff

**Figure 78. Photo. Completed permanent restoration of a grout cap.**

## **RESTORATION MATERIAL**

It is recommended that approved material from the bridge owners be used in the restoration of tendons after invasive testing. For grout restoration, after the existing grout is removed for a test sample, the grout should be patched with an approved prepackaged grout mortar/hydraulic cement grout mortar applied to both internal and external tendons.

Basic materials used for external tendon restoration include the following:

- Approved prepackaged grout/hydraulic cement grout mortar.
- High-performance waterproof tape.
- Epoxy.
- Heat shrink sleeve.
- Elastomeric coat.

Basic materials used for internal tendon restoration include the following:

- Approved prepackaged grout/hydraulic cement grout mortar.
- MAPC.
- Hydraulic cement mortar.
- High-performance waterproof tape.
- Epoxy.
- Elastomeric coating.



## CHAPTER 9. INTERPRETATION OF RESULTS AND COURSES OF ACTION

### BACKGROUND

Grout issues fall into the following categories:

- $\text{Cl}^-$  concentration in excess of the 0.08 wt percent cement limit.
- Air pocket in the duct interior and exposed strand as a consequence of incomplete grout filling or grout subsidence (or both).
- Presence of grout types 1–3 (see chapter 4).

Compounding factors that contribute to determining response actions are presence of free water, the extent of any strand corrosion, and occurrence of strand fractures. This chapter presents a generalized course-of-action decision guide based on a categorization of  $\text{Cl}^-$  and extent of strand corrosion and fractures considering the grout issues and compounding factors. It is recognized that “no one size fits all” and that this guide may be modified, supplemented, or even supplanted by an alternative approach. Specifically, sound engineering judgment must be employed. Ongoing research under FHWA sponsorship is investigating implications of  $\text{Cl}^-$  contaminated PT grout on strand performance.<sup>(43)</sup> Once available, results from this research could modify recommendations made in this report.

### Evaluation Approach and Interpretation

Table 32 lists CD classifications and recommended actions, respectively, for option 1 inspections according to the determined condition of individual tendons. This considers that strands are embedded in sound grout and only CDs, as expressed in terms of four  $\text{Cl}^-$ , are at issue. Conversely, option 2 inspections consider that the same CD classifications for option 1 are an issue as well as PDs (grout structure and presence of any air voids, strand corrosion, or strand fractures), as listed in table 33. Based on findings for either inspection option, individual tendons are assigned a grade from 1 to 10—the higher the grade, the more problematic the tendon condition.

For option 2, assigning a tendon grade based on the determined CDs and PDs and projecting any resultant action requires multiple considerations. For example, if it is determined that  $\text{Cl}^-$  is less than or equal to 0.08 wt percent cement (CD1) and a grout air pocket is noted (PD1), then a grade of 2 is assigned, and no action (A1) is recommended (see table 33). If the air pocket is long and larger than 0.5 inches, action A6 may be considered by regrouting the void. However, if strands also exhibit surface corrosion but no section loss (PD4), then the grade 6 is assigned and actions A3 and A6 result. In other words, the highest PD determines the grade and recommended action. The term “section loss” refers to any reduced cross section for all strands in a particular tendon, as affected by fractures. For example, if a tendon has 22 strands and 1 has fractured but the others remain load bearing, then section loss is 4.5 percent (PD5 in table 33) in combination with other deficiencies. If grade 8 CD3 is selected, actions A2, A4, A5, and A6 are recommended. Conversely, if there are 18 strands, then 1 fracture translates to 5.6 percent section loss (PD6), which is a grade of 10, and actions A2 and A4 through A8 should be taken.

**Table 32. CD classifications as determined by grout  $Cl^-$  levels from an option 1 inspection and resultant recommended actions.**

<b>CD<sup>a</sup></b>					
CD1	$Cl^- \leq 0.08$	X			
CD2	$0.08 < Cl^- \leq 0.20$		X		
CD3*	$0.2 < Cl^- \leq 0.50^b$			X	
CD4	$Cl^- > 0.50^b$				X
<b>Action</b>		<b>Grade</b>			
		<b>1</b>	<b>5</b>	<b>7</b>	<b>9</b>
A1	None	X			
A2	Expand sampling			X	X
A3	Reinspect in 5 years		X		
A4	Reinspect in 2 years			X	X
A5	Tendon monitoring			X	X

<sup>a</sup> Chloride concentration units are wt percent cement.

<sup>b</sup> If strand corrosion or fracture(s) are found (PD5 or PD6 under option 2 in table 33), then grade 9 or 10 should be assigned as appropriate per option 2 actions.

\* Revised on 10/22/2013

**Table 33. CD and PD classifications as determined by grout  $Cl^-$  levels and in-place grout structure by an option 2 inspection and resultant recommended actions.**

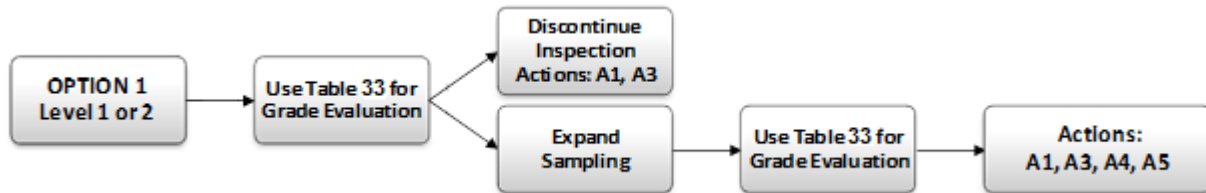
<b>CD<sup>a</sup></b>											
CD1	$Cl^- \leq 0.08$	X	X	X	X						
CD2	$0.08 < Cl^- \leq 0.20$					X	X				
CD3*	$0.2 < Cl^- \leq 0.50$							X	X		
CD4	$Cl^- > 0.50$									X	X
<b>PD</b>											
PD0	Sound grout	X									
PD1	Grout air pocket		X	X	X	X	X	X	X	X	X
PD2	Exposed strand/tendon			X	X	X	X	X	X	X	X
PD3	Soft or segregated grout				X	X	X	X	X	X	X
PD4	Tendon surface corrosion (no section loss)						X	X	X	X	X
PD5	Tendon surface corrosion (< 5 percent section loss)								X	X	X
PD6	Tendon with partial or full fracture ( $\geq 5$ percent section loss)										X
<b>Action</b>		<b>Grade</b>									
		<b>1</b>	<b>2</b>	<b>3</b>	<b>4</b>	<b>5</b>	<b>6</b>	<b>7</b>	<b>8</b>	<b>9</b>	<b>10</b>
A1	None	X	X								
A2	Expand sampling							X	X	X	X
A3	Reinspect in 5 years				X	X	X				
A4	Reinspect in 2 years							X	X	X	X
A5	Tendon monitoring							X	X	X	X
A6	Consider repairing deficiency as necessary <sup>b</sup>		X	X	X	X	X	X	X	X	X
A7	Structural evaluation/load rating										X
A8	Tendon replacement										X

<sup>a</sup> Chloride concentration units are wt percent cement.

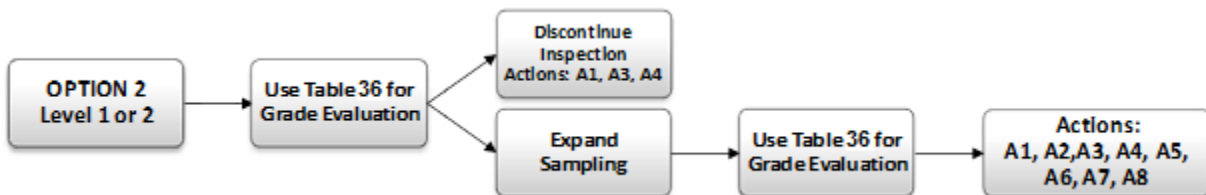
<sup>b</sup> This applies to PD1, PD2, and PD3.

\* Revised on 10/22/2013

The protocol is simpler in the option 1 inspection case in that the determined  $Cl^-$  translates directly to a respective grade as indicated in table 32 and table 33. However, if strand corrosion and/or fractures are observed as part of option 1 grout sampling activities, then, as indicated, this reverts the action recommendation from table 32 to that in table 33. Figure 79 and figure 80 summarize these decision processes for options 1 and 2, respectively.



**Figure 79. Flowchart. Inspection, sampling, evaluation, and actions for levels 1 and 2 inspections for option 1.**



**Figure 80. Flowchart. Inspection, sampling, evaluation, and actions for levels 1 and 2 inspections for option 2.**

Evaluation of test and inspection results should be performed by treating tendons of a common type as a group and assigning a grade to individual tendons of that group according to the protocol provided in table 32 for option 1 inspection and table 33 for option 2. An option 1 inspection may be either level 1 with no further sampling required or expanded to level 2, which involves additional sampling depending on the table 32 grading. Typically, for an option 2 level 2 inspection, all tendons of the types considered are inspected.

## Examples

### *1. Typical Span-by-Span Segmental Bridge with Complete Grouting Records*

Preliminary information is as follows:

- Grouting record was available.
- Option 1 (level 2) inspection was selected.

#### **Inspection Results:**

Inspection results are as follows:

- A total of 10 samples were collected from 10 different tendons.
- There were no other deficiencies.

- Laboratory grout test results indicated that 60 percent of the samples have  $Cl^-$  content in the range of 0.08 to 0.2 wt percent cement, and 40 percent of samples have  $Cl^-$  content lower than 0.08 wt percent cement.

**Recommended Course of Action:**

Table 32 should be used as follows:

- **Group 1 tendons (60 percent of the total samples):** 0.08 to 0.2 wt percent cement  $Cl^-$  content = CD2, and grade 5 is assigned. As a result, action A3 is required.
- **Group 2 tendons (40 percent of the total samples):** Less than 0.08 wt percent cement  $Cl^-$  content = CD1, and grade 1 is assigned. As a result, action A1 is required.

**Conclusions:**

Discontinue inspection and reinspect all tendon types in group 1 in 5 years.

**2. Typical Span-by-Span Segmental Bridge**

Preliminary information is as follows:

- No grouting record was available.
- Option 2 level 2 inspection was conducted (95 percent confidence level).

**Inspection Results:**

Inspection results are as follows:

- All grout samples collected have  $Cl^-$  content below 0.08 wt percent cement.
- A total of 30 percent of the tendons inspected have soft/segregated grout, voids, exposed strands, and corrosion with more than 5 percent section loss.
- A total of 25 percent of the tendons inspected have voids, exposed strands, with corrosion with less than 5 percent section loss.
- A total of 45 percent of the tendons inspected have no issues.

**Recommended Course of Action:**

Table 33 should be used as follows:

- **Group 1 tendons (30 percent of the total samples):** Soft/segregated grout, voids, and corrosion with more than 5 percent section loss = CD1, PD2, PD3, and PD6, and grade 10 is assigned. As a result, actions A2 and A4 through A8 are required.



- **Group 2 tendons (25 percent of the total samples):** Voids with corrosion of less than 5 percent section loss = CD1, PD1, PD2, and PD5, and grade 4 is assigned. As a result, actions A2 and A4 through A6 are required.

### **Conclusions:**

Based on the examples, the following procedure was created:

1. Expand inspection to all tendon types in groups 1 and 2.
2. Reevaluate the results of the new samples, including the previous samples.
3. Make a decision based on the combined results either to inspect all tendons or discontinue inspection.

Probable final course of actions could be the combination of the following items:

- Replace corroded tendons with section loss larger than 5 percent.
- Repair deficiencies, such as regrouting voids.
- Perform structural evaluation/load rating considering PT section loss.
- Determine that tendon monitoring may not be necessary since  $Cl^-$  is below 0.08 wt percent cement.
- Reinspect the tendons in 2 years. If the results are satisfactory, the next reinspection period can be adjusted to 5 years.

### **Reinspections, Non-Destructive Testing (NDT), and Monitoring**

It is intended that the term “reinspect” in table 33 refers to further inspection and sampling, as described in chapters 5 through 8 of this report, in order to either increase reliability of the findings or determine if any deterioration has progressed since an earlier inspection and sampling. In addition, consideration can be given to adapting one or more of the following NDT technologies that are available:

- Main magnetic flux method.
- Magnetic flux leakage method.
- Pulsed eddy current examination method.
- Magnetostrictive sensor technology.
- Microwave thermorelectometry.
- Remnant magnetic system.

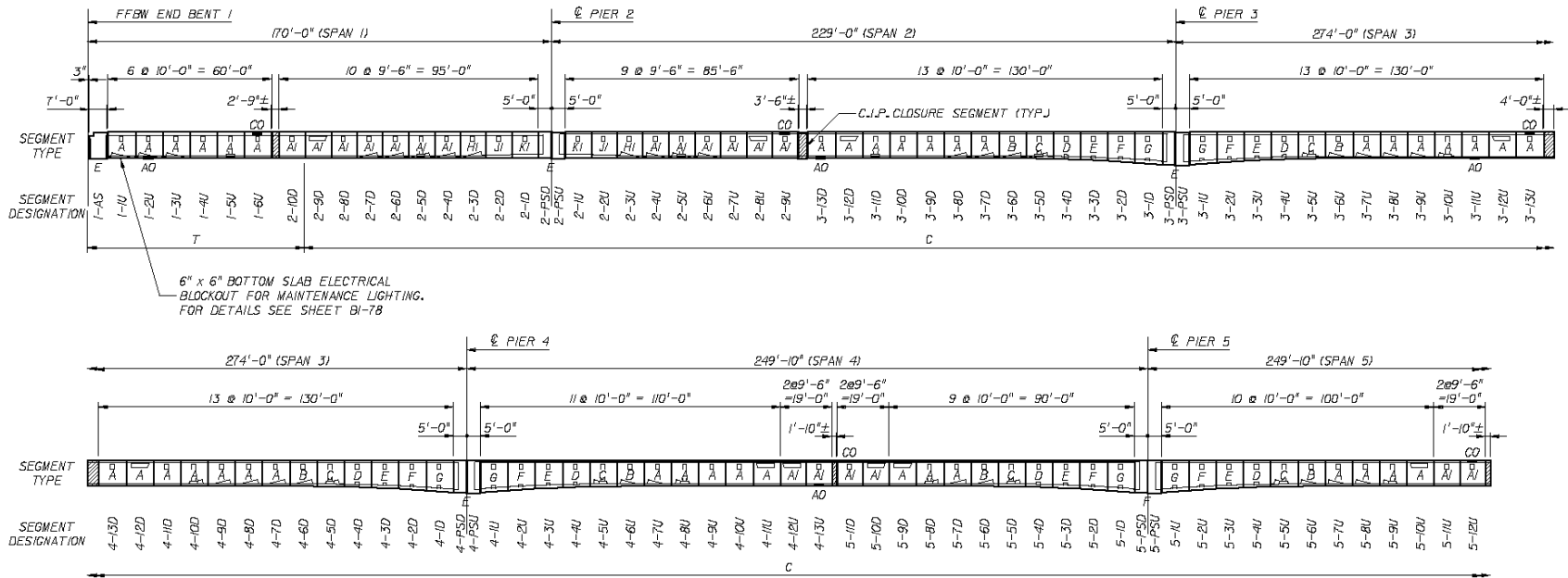
- Vibration method.
- Ultrasonic pulse velocity.
- Acoustic emission.

Each of these has attributes, but a common limitation is that section loss or fracture of wires or strands within internal tendons and within deviation blocks and anchorages of external tendons, which is where problems are most likely to occur, cannot currently be detected by these methods. Improvement in these NDT techniques remains an area of active ongoing research.

Monitoring tendons for wire and strand breaks is an option for assuring that any fractures are detected in a timely manner. Passive acoustic emission instrumentation with remote monitoring is an option in this regard, and commercial systems are available for implementation.



# APPENDIX A. TYPICAL BALANCED CANTILEVER BRIDGE PLANS

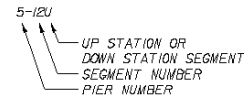


97

**LEGEND:**

- AS: ABUTMENT SEGMENT
- PS: PIER SEGMENT
- AO: 2'-8" x 3'-6" MAINTENANCE ACCESS OPENING LOCATED IN THE BOTTOM SLAB.
- CO: 3'-0" x 2'-0" TEMPORARY ACCESS HOLE LOCATED IN THE TOP SLAB.
- E: EXPANSION BEARING
- F: FIXED BEARING
- T: DENOTES SEGMENT IN TANGENT SECTION OF HORIZONTAL CURVE
- C: DENOTES SEGMENT IN CURVED SECTION OF HORIZONTAL CURVE

**SEGMENT DESIGNATION**



**NOTES:**

1. SPAN LENGTHS AND SEGMENT DIMENSIONS ARE MEASURED ALONG THE CENTER LINE OF BOX GIRDER.
2. LOCATION OF TEMPORARY SUPPORTS USED FOR DESIGN IS SHOWN ON SHEETS RI-94 TO RI-96.
3. FOR BLISTER AND DEVIATOR TYPE AND LOCATION, SEE SHEETS BI-53 TO BI-60.

**Figure 81. Illustration. Segment layout—part 1.**

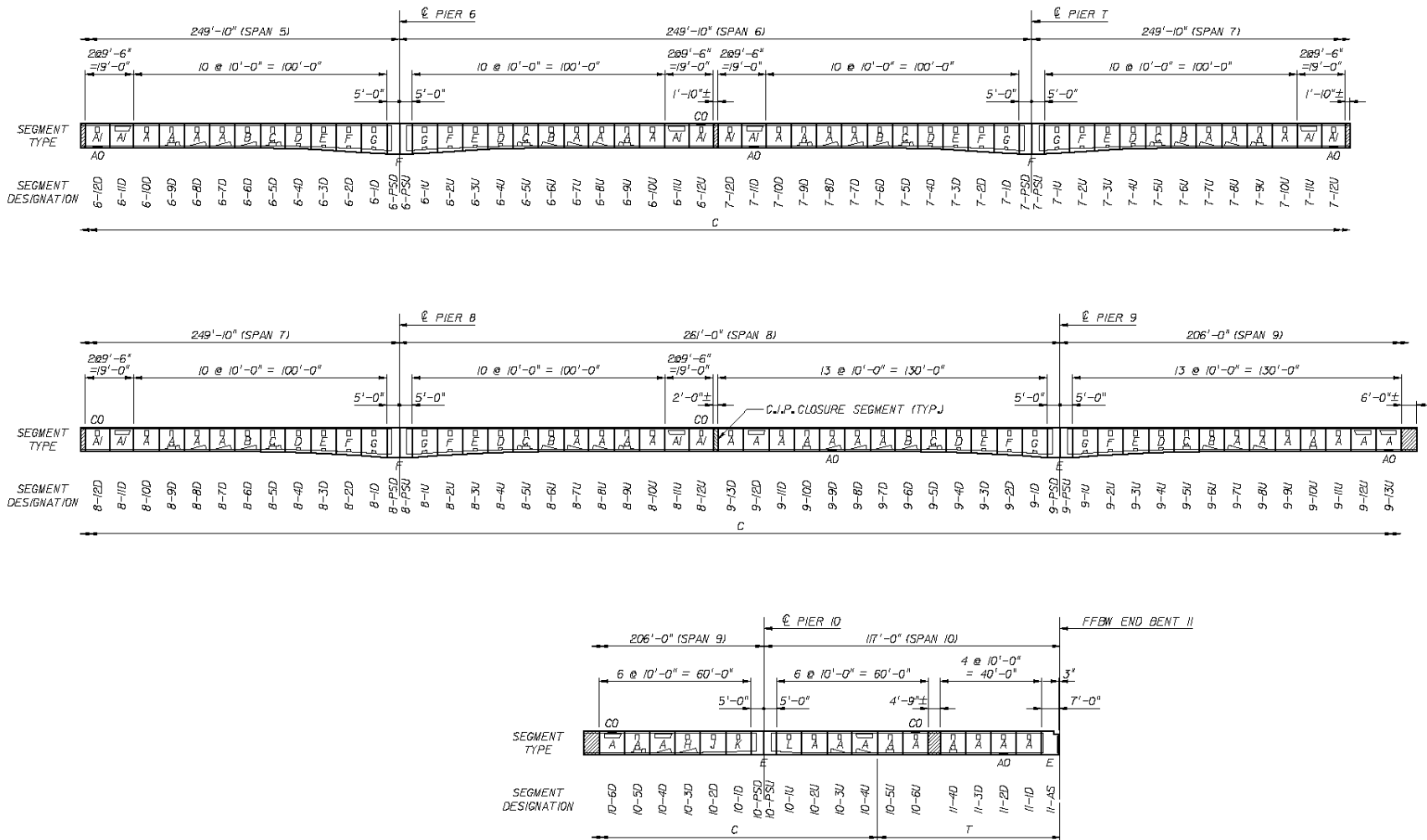


Figure 82. Illustration. Segment layout—part 2.

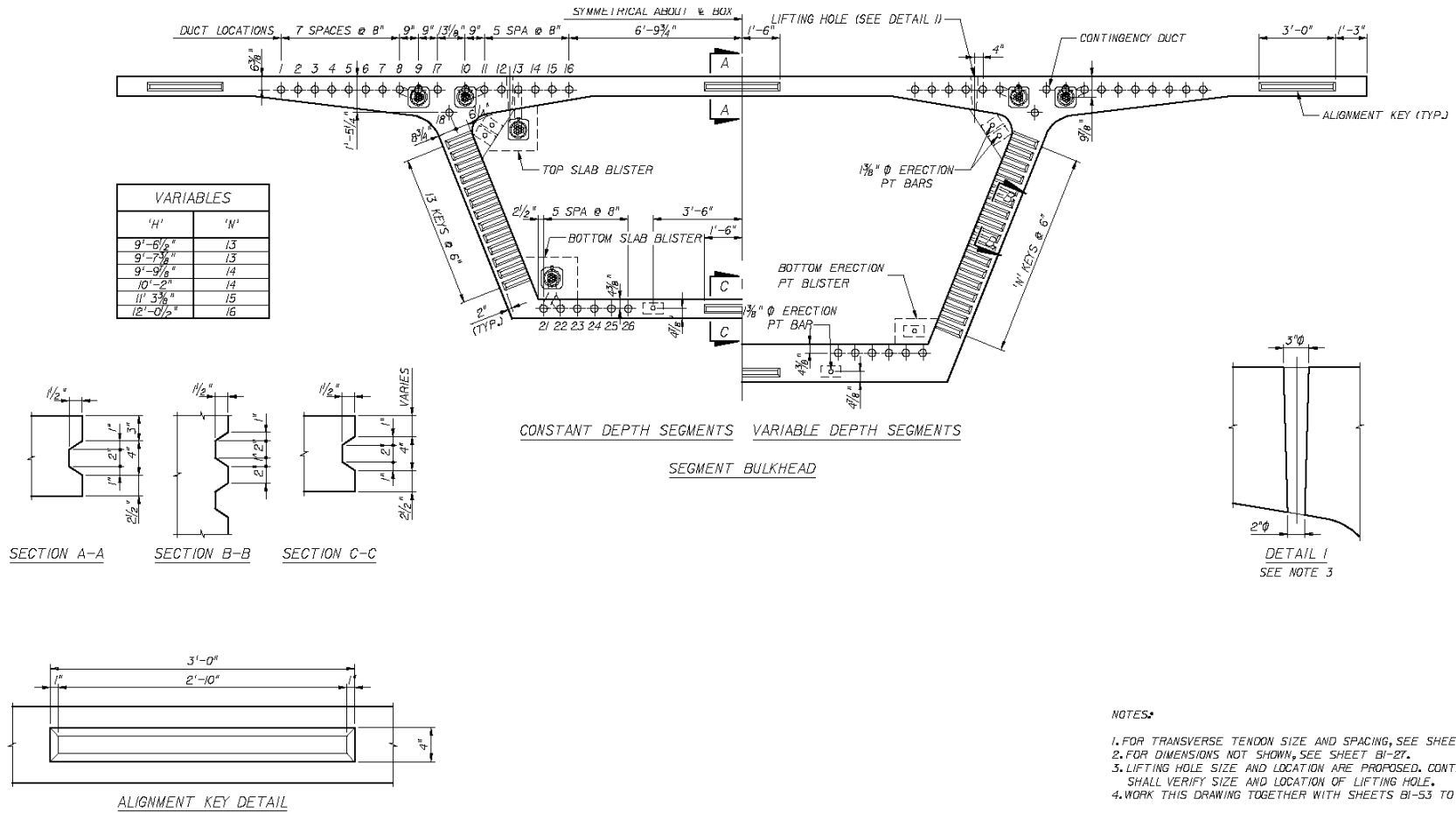


Figure 83. Illustration. Bulkhead details.

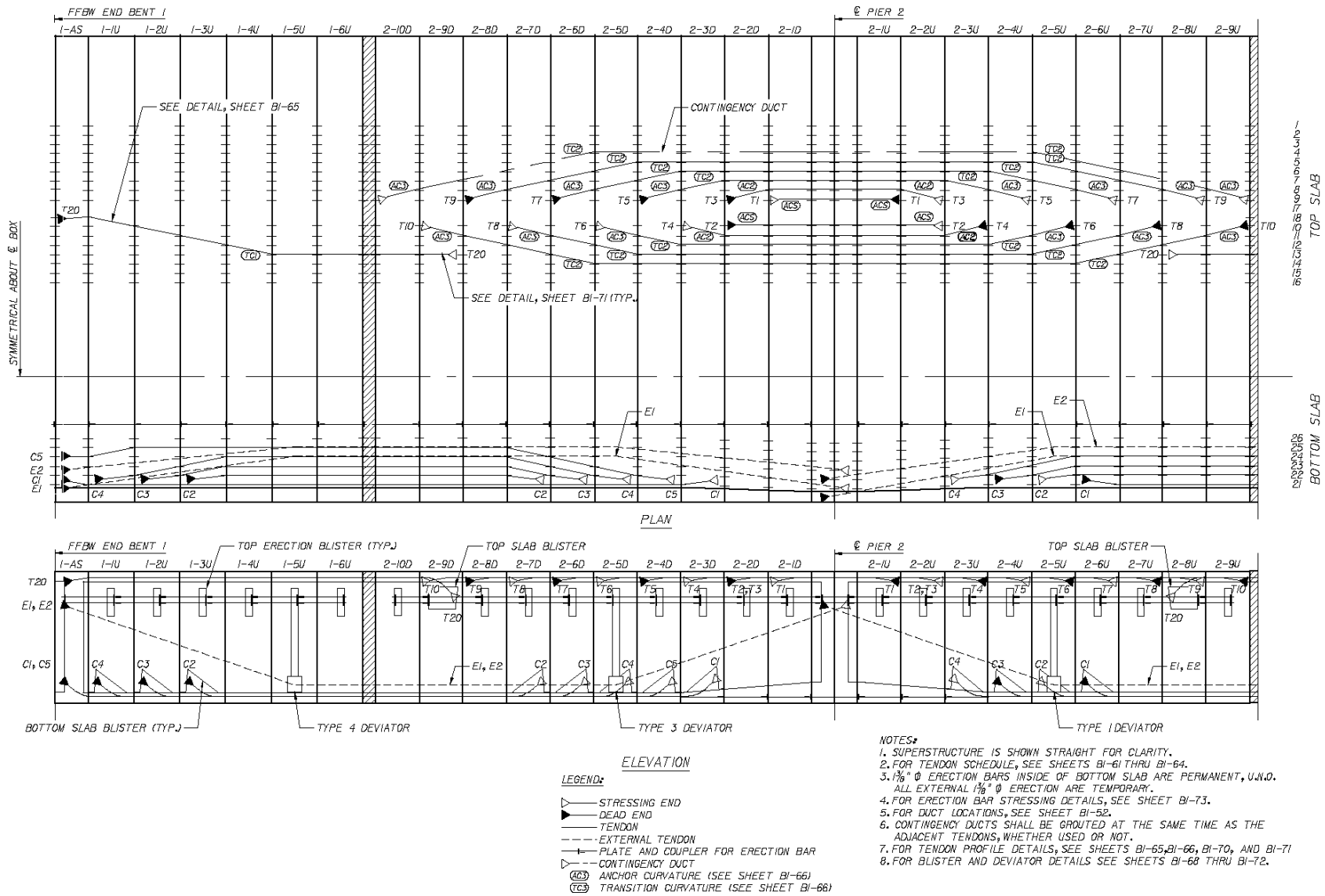


Figure 84. Illustration. Longitudinal PT layout—part 1.

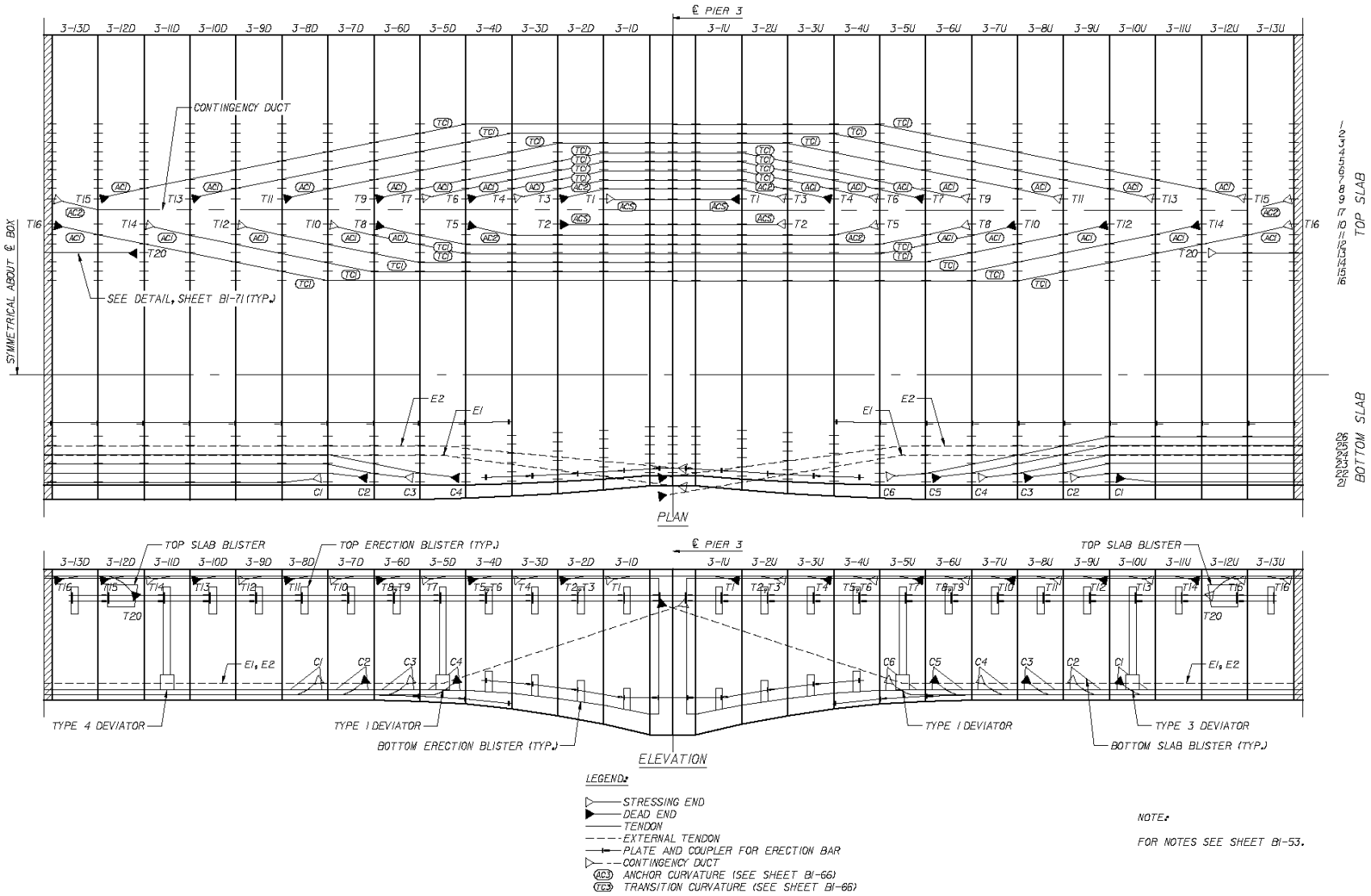


Figure 85. Illustration. Longitudinal PT layout—part 2.



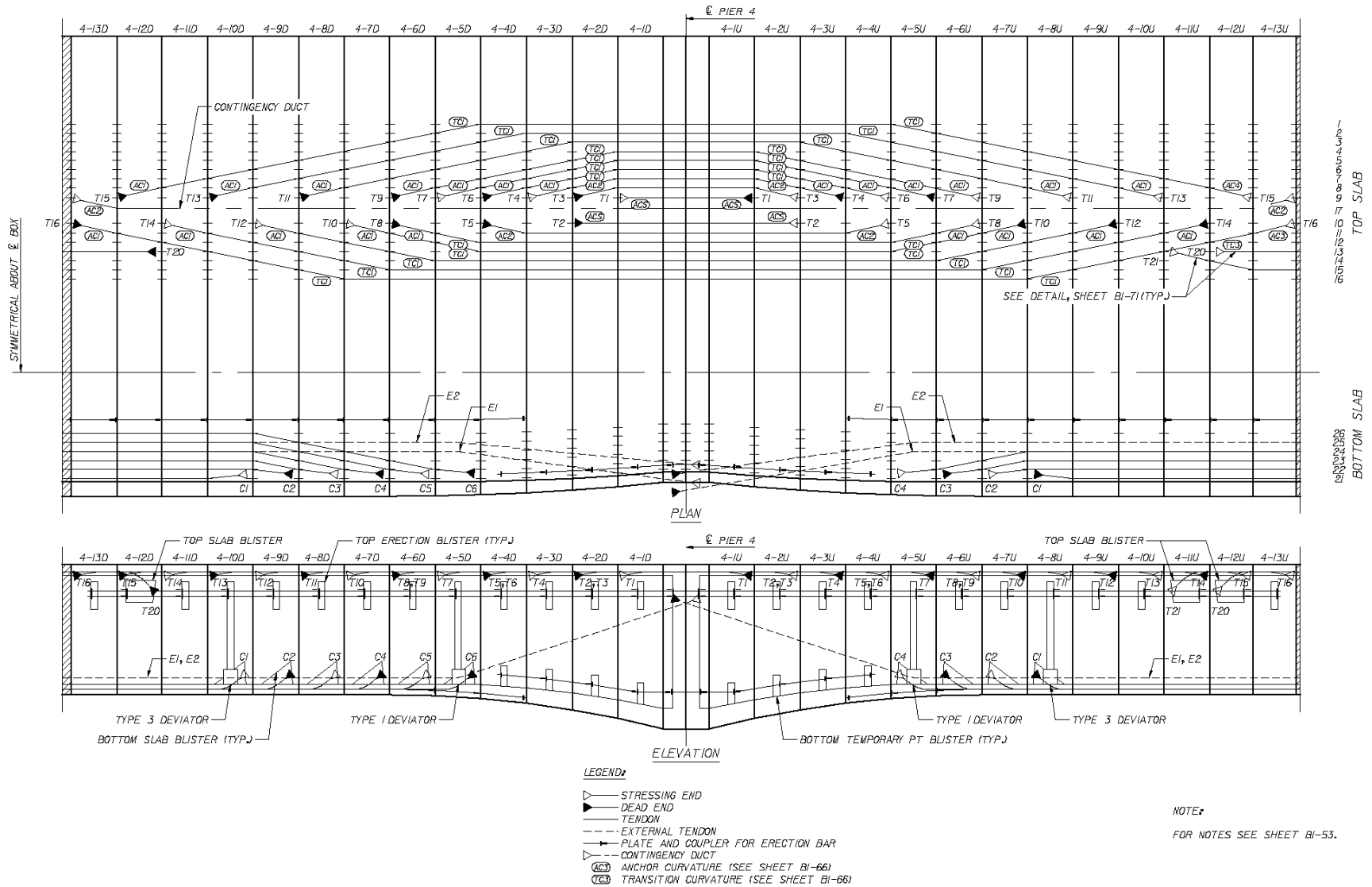


Figure 86. Illustration. Longitudinal PT layout—part 3.

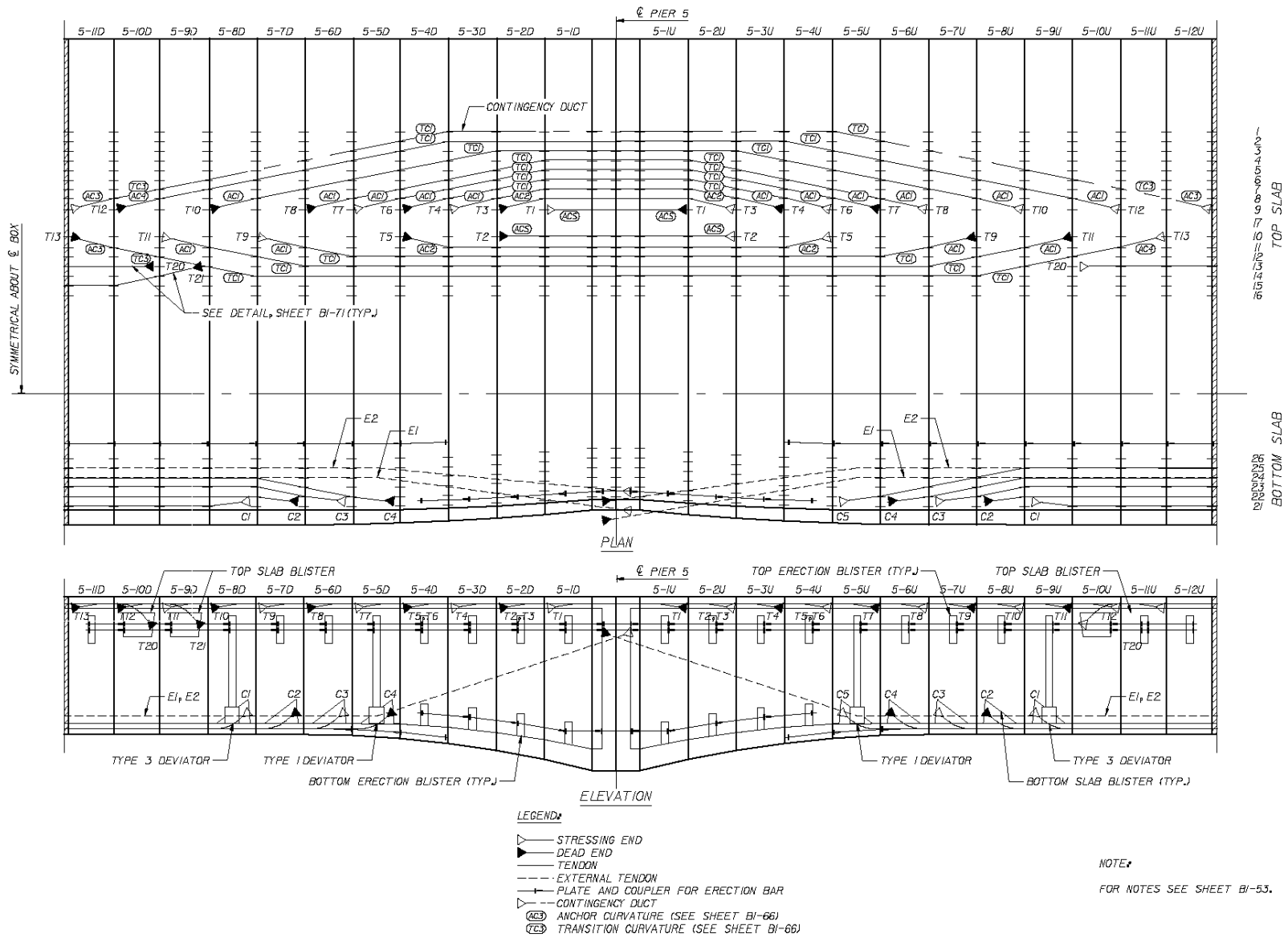


Figure 87. Illustration. Longitudinal PT layout—part 4.

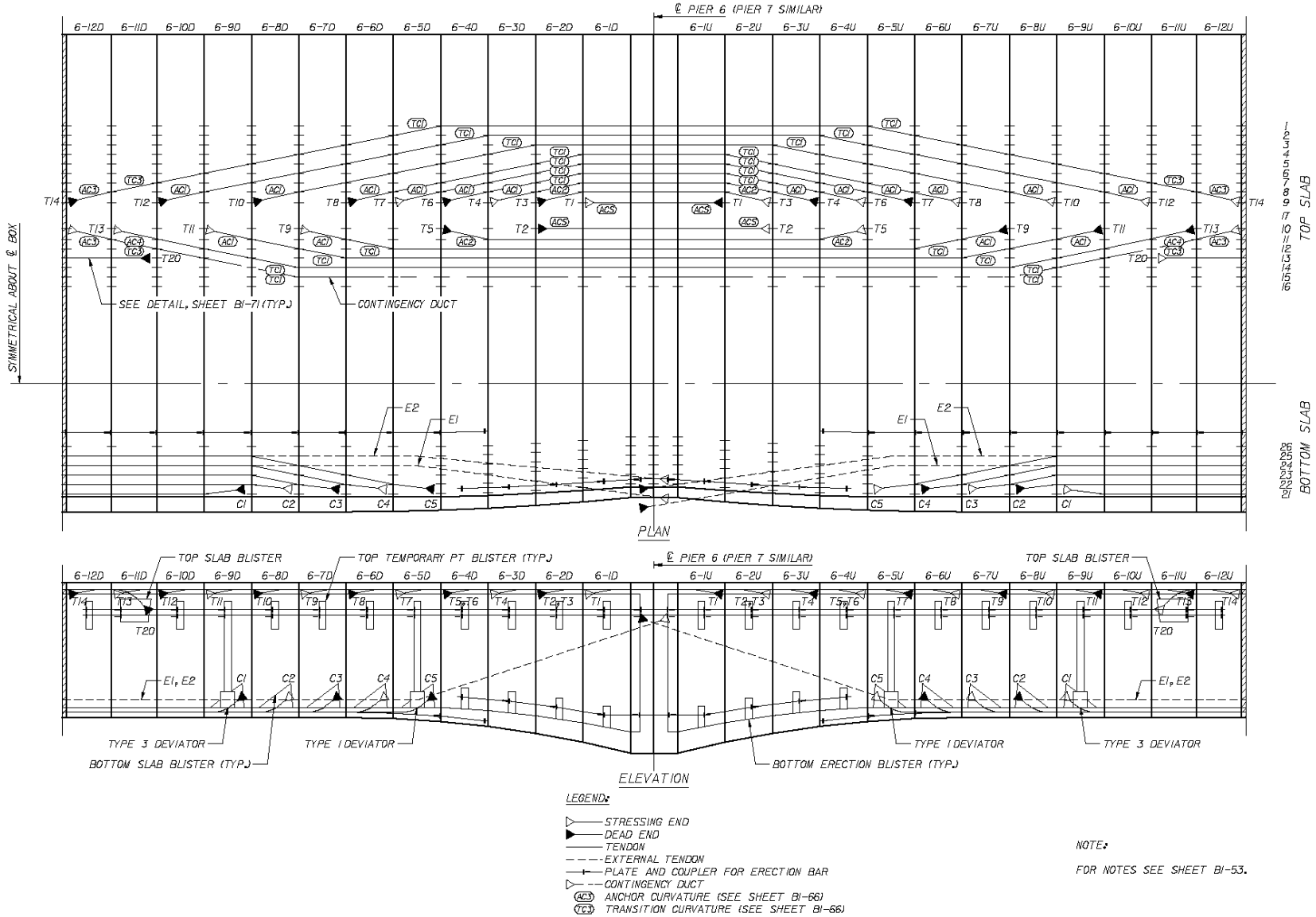


Figure 88. Illustration. Longitudinal PT layout—part 5.

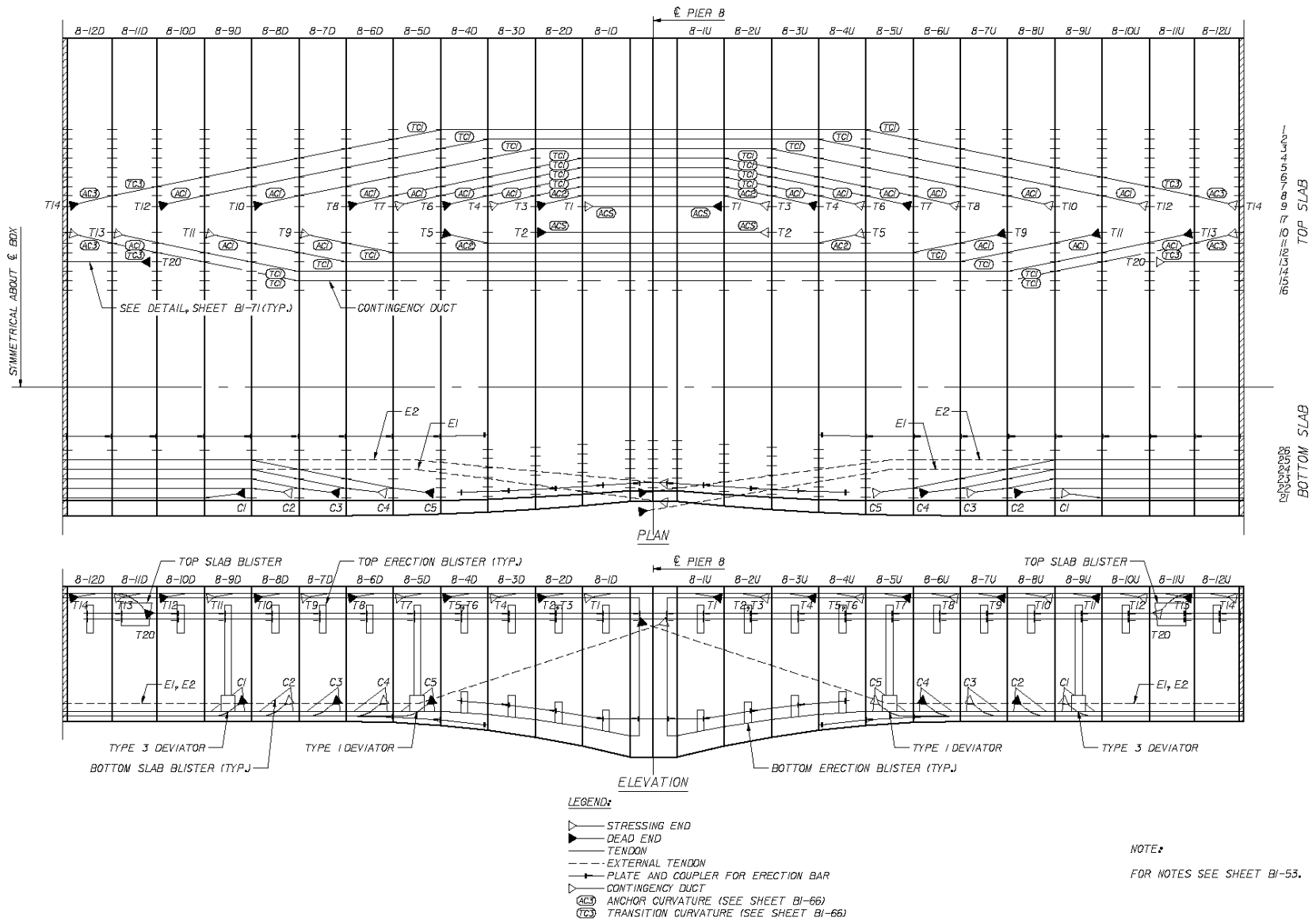


Figure 89. Illustration. Longitudinal PT layout—part 6.

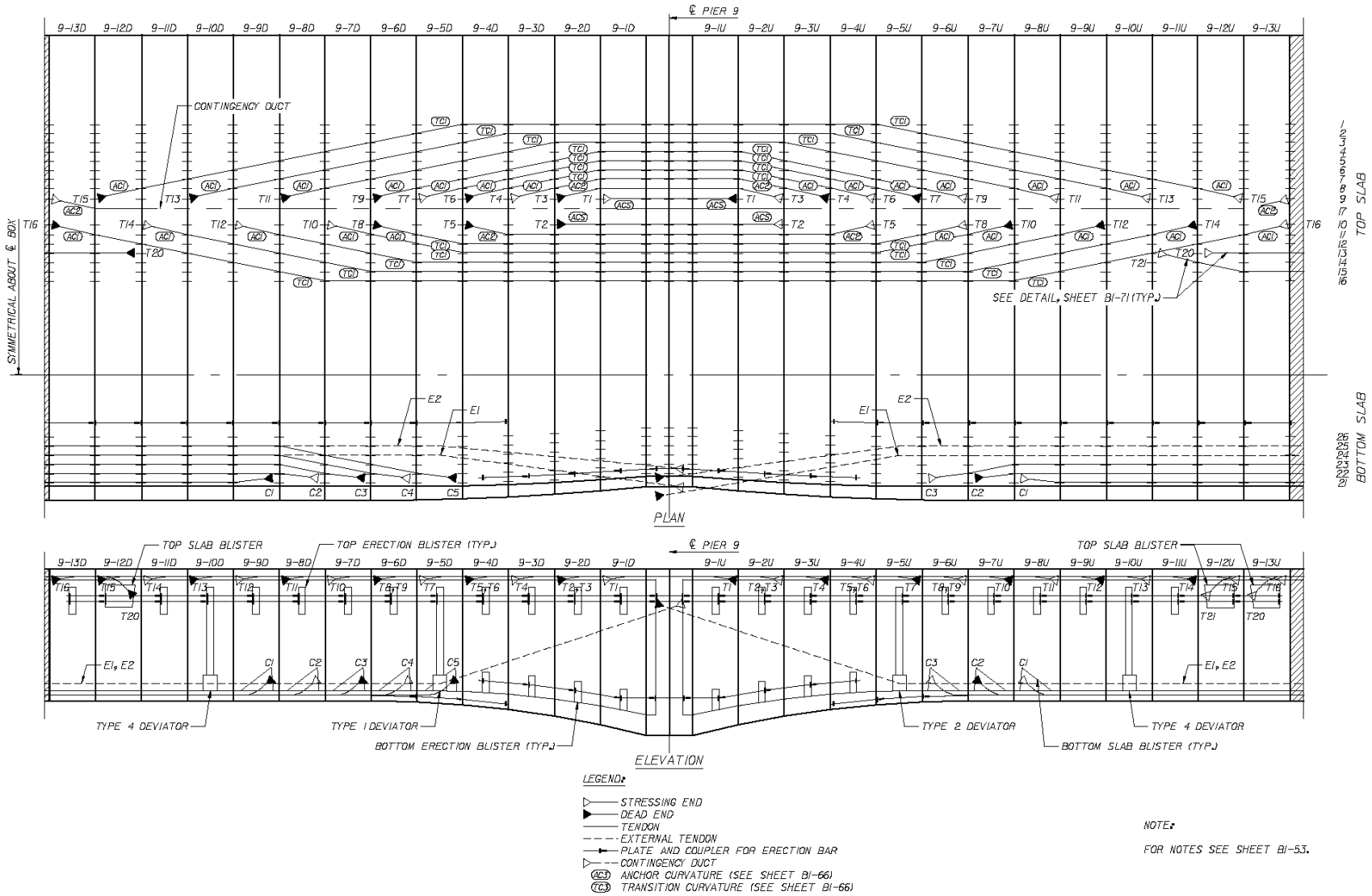


Figure 90. Illustration. Longitudinal PT layout—part 7.

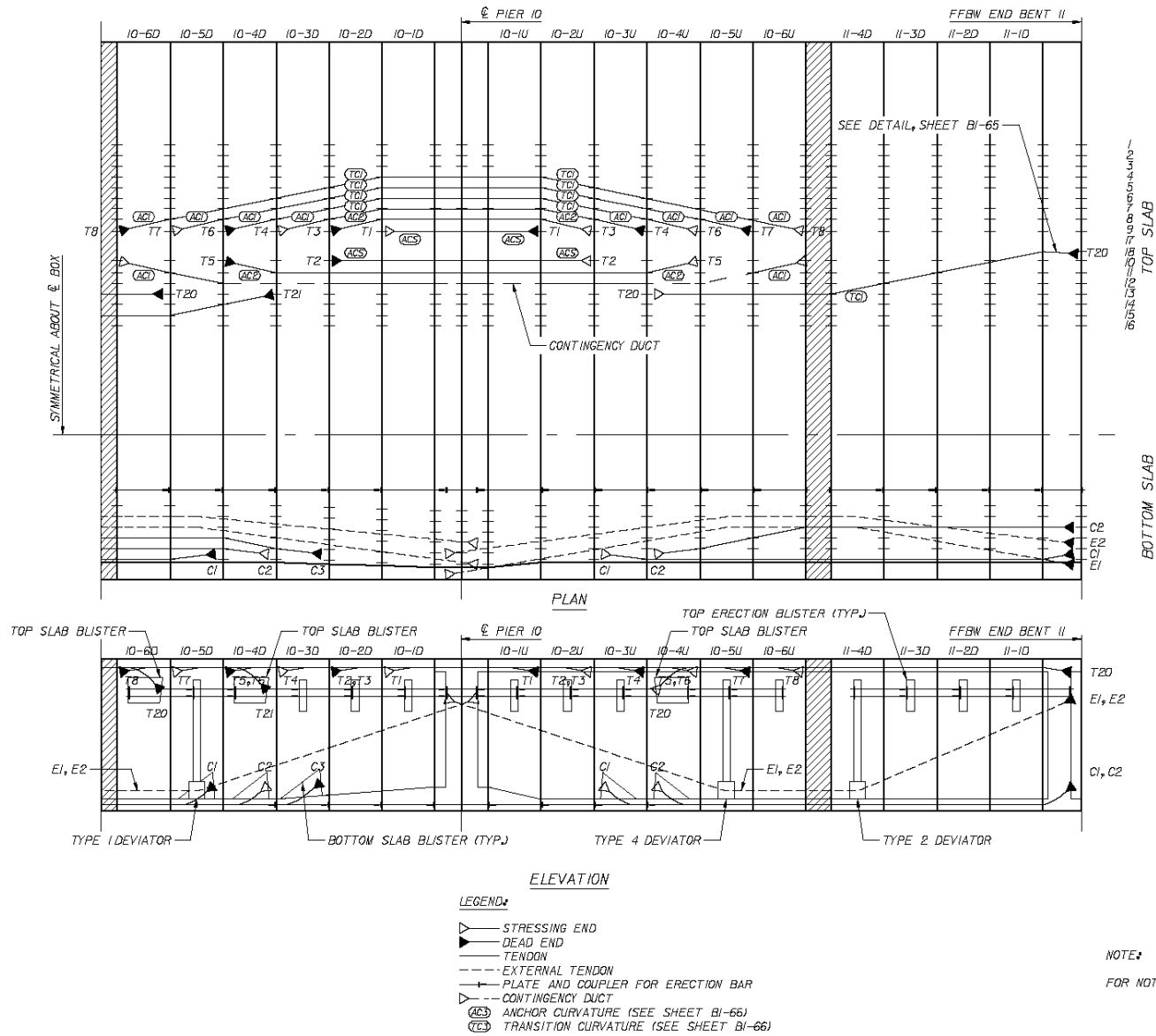


Figure 91. Illustration. Longitudinal PT layout—part 8.



## APPENDIX B. TYPICAL SPLICED GIRDER BRIDGE PLANS

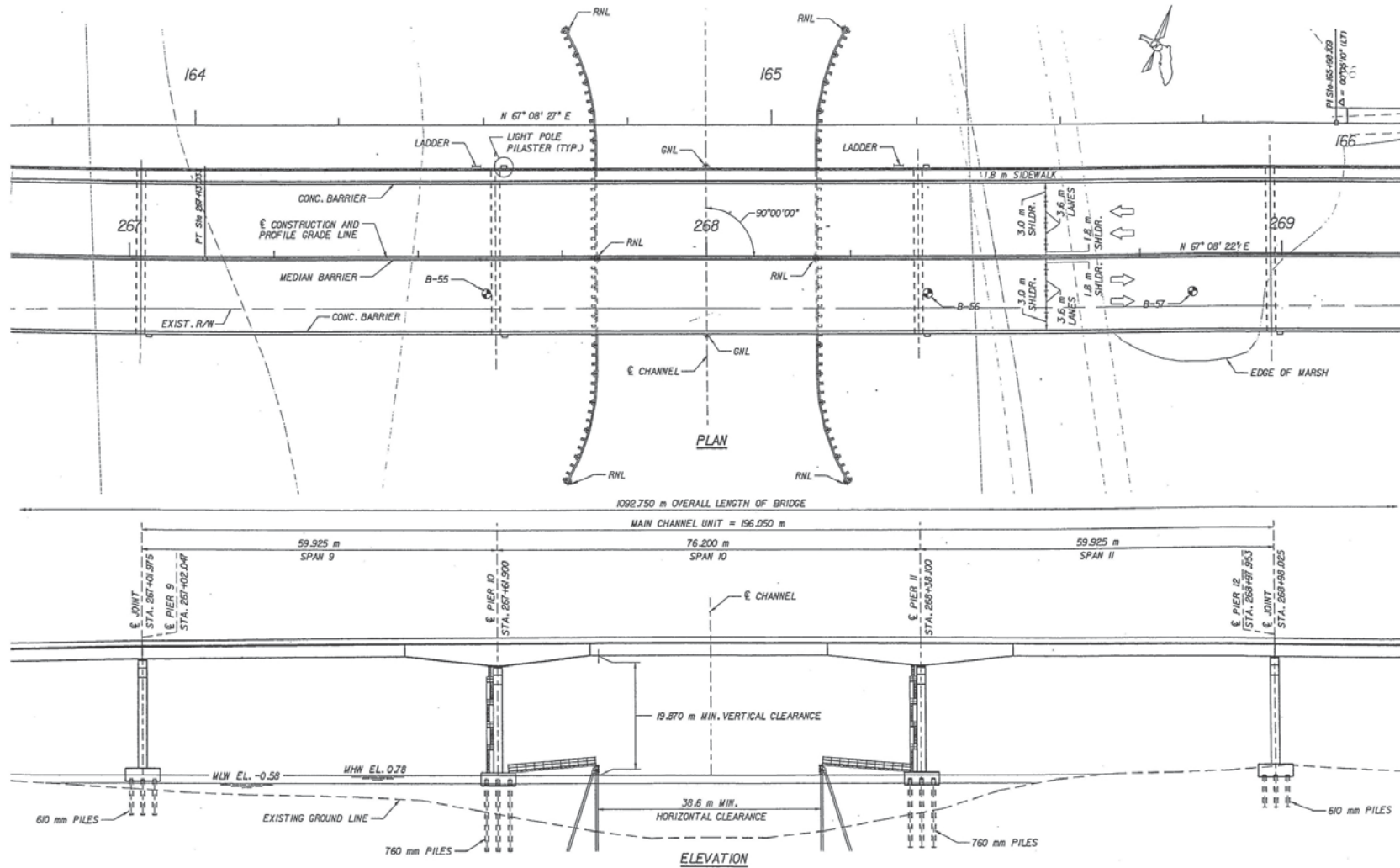


Figure 92. Illustration. Plan and elevation—main channel unit.



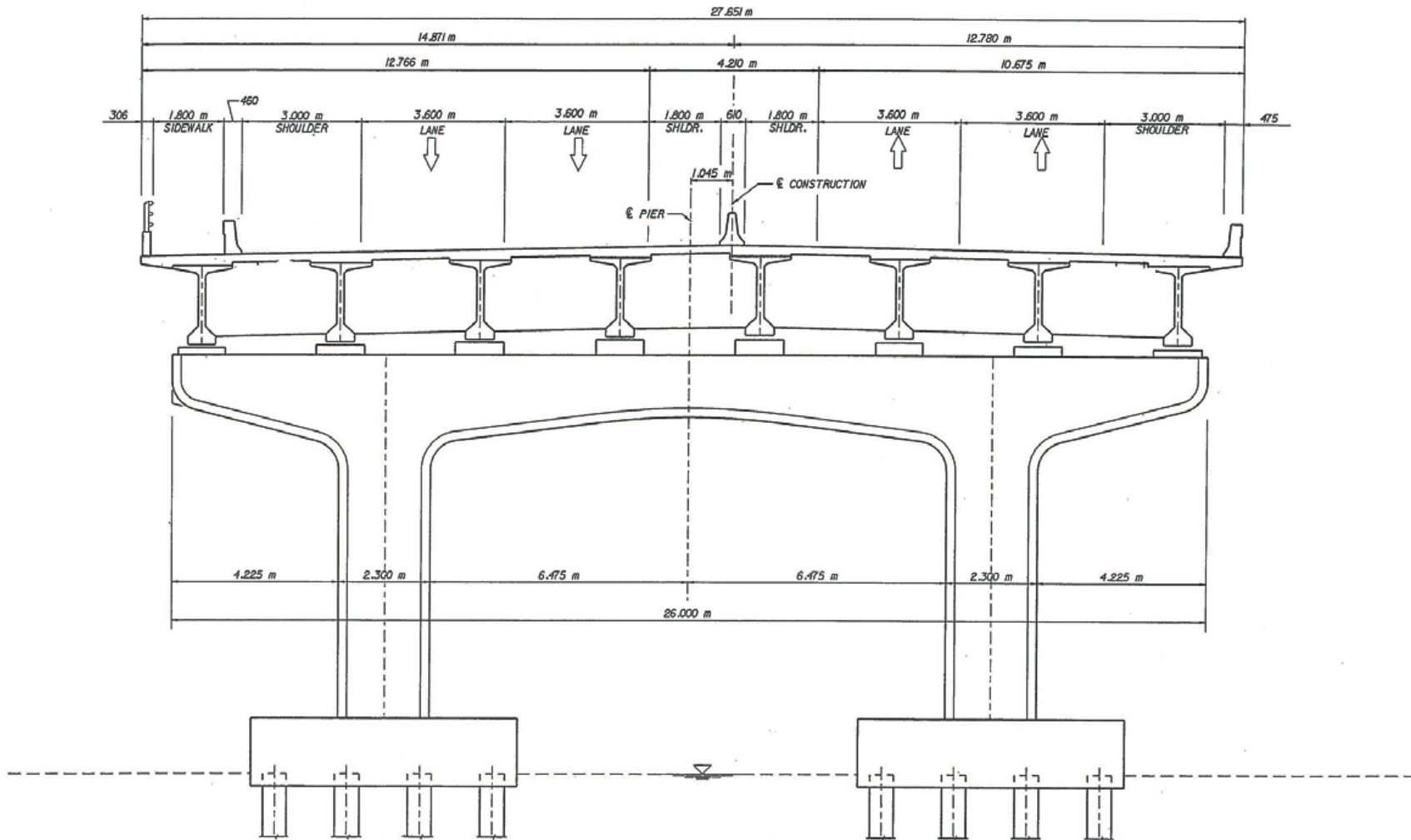
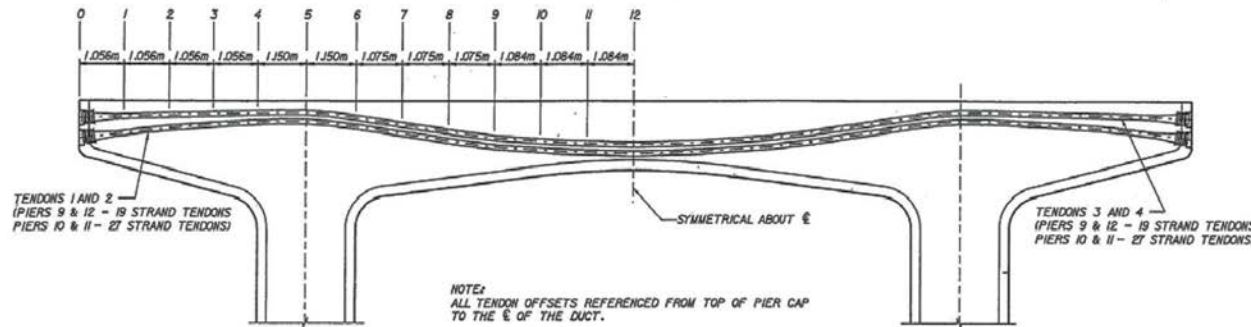
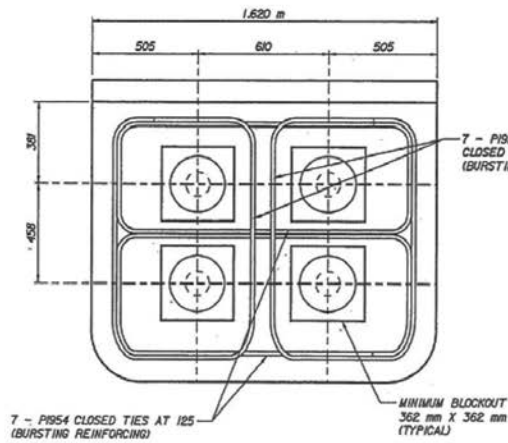


Figure 93. Illustration. Bridge section.



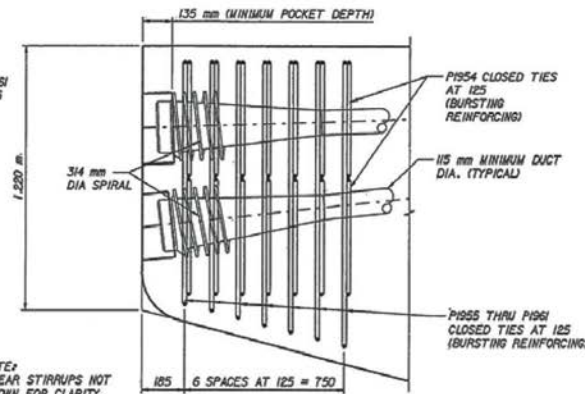
TENDON OFFSETS													
OFFSET LOCATION	0	1	2	3	4	5	6	7	8	9	10	11	12
TENDONS 1 & 2	839 mm	714 mm	607 mm	530 mm	476 mm	457 mm	567 mm	726 mm	891 mm	1,028 mm	1,113 mm	1,158 mm	1,181 mm
TENDONS 3 & 4	381 mm	343 mm	310 mm	285 mm	261 mm	255 mm	364 mm	522 mm	687 mm	825 mm	911 mm	955 mm	999 mm

**PIER CAP TENDON PROFILES**  
(PIERS 9 THRU 12)



**ANCHORAGE DETAIL**

NOTE: BLOCKOUTS SHALL BE FILLED WITH NON-SHRINK GROUT IMMEDIATELY UPON COMPLETION OF JACKING OPERATION.



**ANCHOR ZONE REINFORCEMENT**  
(PIERS 9 THRU 12)

**GENERAL NOTES FOR POST-TENSIONED PIER CAPS**

**MATERIAL PROPERTIES**

C.I.P. CONCRETE  
PIERS  
CLASS III  $f'_c = 38 \text{ MPa}$   
 $E = 26230 \text{ MPa}$

**PRESTRESSING STEEL**

STRANDS - ASTM A416, GRADE 1860 LOW  $\lambda$ X  
MODULUS OF ELASTICITY = 193053 MPa  
STRAND DIA = 15 mm (0.6 INCHES)

**REINFORCING STEEL**

ASTM A615/A616, GRADE 420  
MODULUS OF ELASTICITY 199948 MPa

**PROPERTIES FOR ANALYSIS AND DESIGN**

MAXIMUM JACKING STRESS = 75 Fpu (1396 MPa)  
MAXIMUM ANCHORING STRESS = 75 Fpu (1396 MPa)  
AT END OF SEATING ZONE  
MAXIMUM ANCHORING STRESS = 70 Fpu (1303 MPa)  
ANCHOR SET = 6 mm  
FRICTION COEFFICIENT = 0.25 (PLASTIC DUCT)  
WOBBLE COEFFICIENT = 0.00066 (PER METER)

**SEQUENCE OF OPERATION**

1. CONCRETE SHALL OBTAIN FULL 28 DAY STRENGTH PRIOR TO POST-TENSIONING
2. JACK FROM ONE SIDE ONLY
3. STRESS ALL TENDONS PRIOR TO SETTING GIRDERS ON PIER CAP.
4. TENDONS 1 AND 2 SHALL BE JACKED FIRST FOLLOWED BY TENDONS 3 AND 4. JACK TENDON 1 TO HALF THE SPECIFIED STRESSING FORCE, THEN JACK TENDON 2 TO THE FULL SPECIFIED JACKING LOAD. COMPLETE THE TENSIONING OF TENDON 1. AFTER COMPLETION OF THE FIRST STAGE POST-TENSIONING, JACK TENDONS 3 AND 4. JACK TENDON 3 TO HALF THE SPECIFIED STRESSING FORCE, THEN JACK TENDON 4 TO THE FULL SPECIFIED STRESSING FORCE. COMPLETE THE TENSIONING OF TENDON 4.
5. JACKING FORCE FOR 19 STRAND TENDON = 374 kN. JACKING FORCE FOR 27 STRAND TENDON = 5278 kN.
6. FOR ADDITIONAL NOTES RELATED TO DUCTS, TENDON GROUTING AND POST-TENSIONING OPERATIONS SEE GENERAL NOTES FOR POST-TENSIONING MAIN CHANNEL UNIT.

**Figure 94. Illustration. Pier cap PT details.**

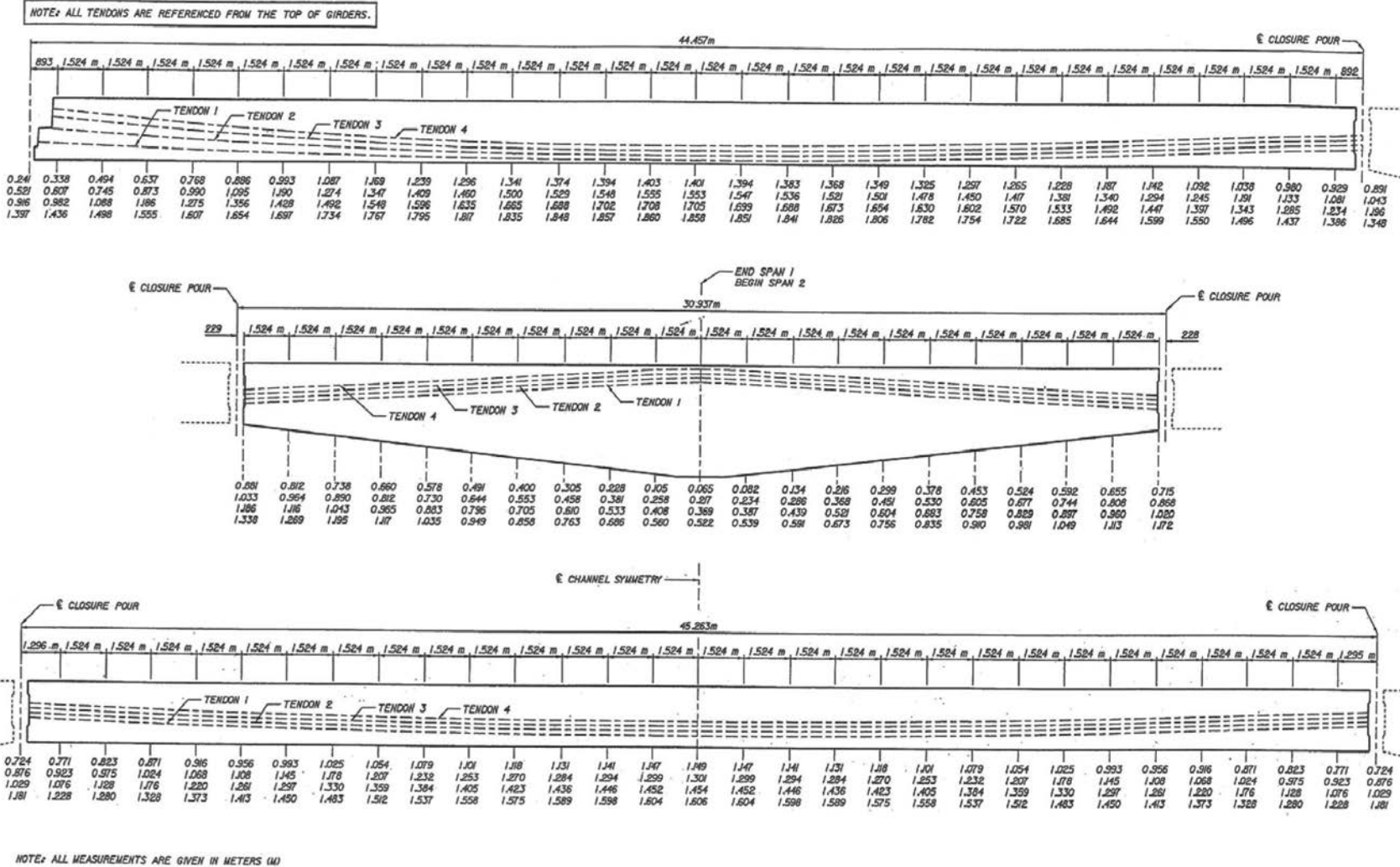


Figure 95. Illustration. Tendon profile—main channel unit.

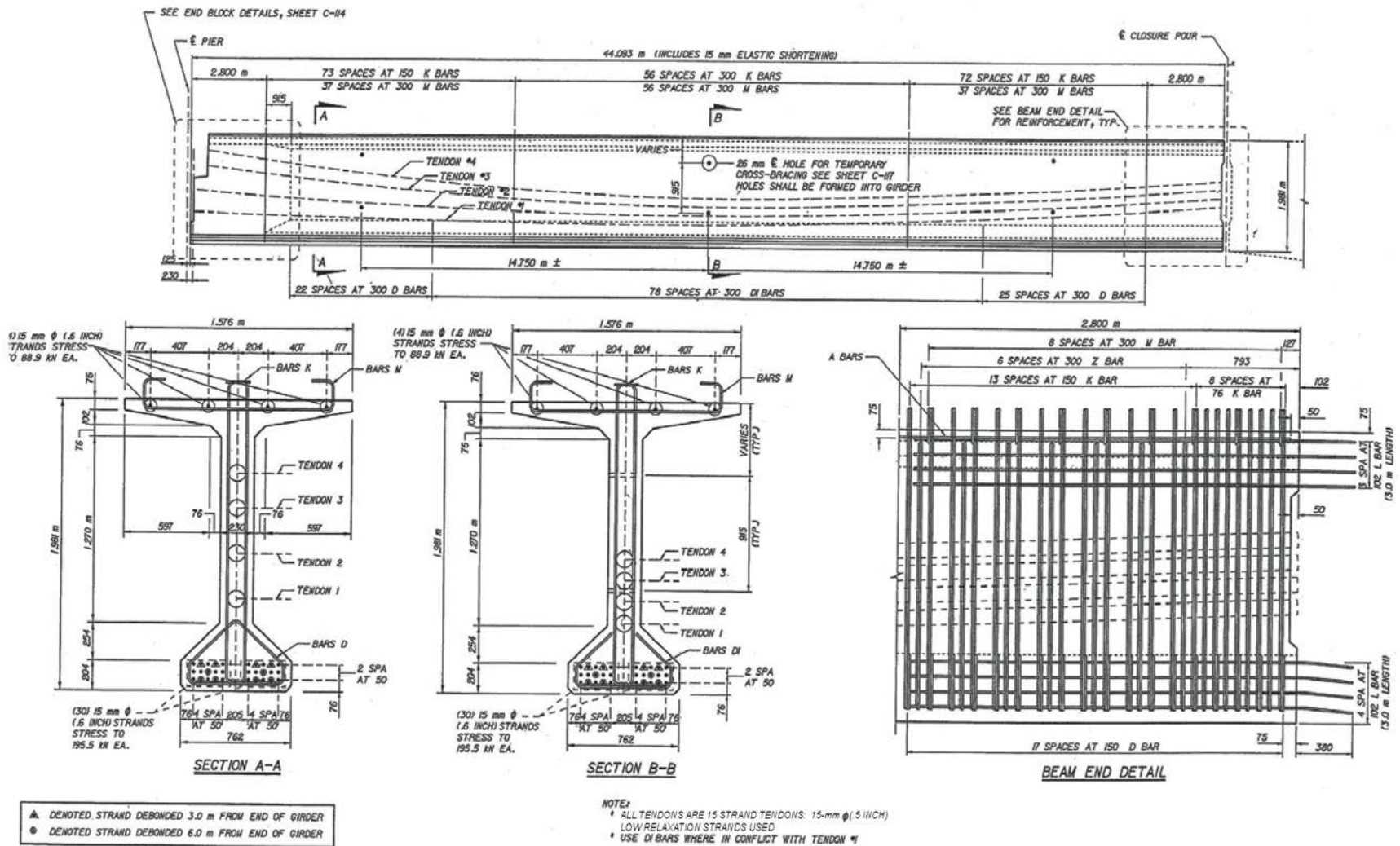


Figure 96. Illustration. Modified Florida bulb-T78 beam end segment.

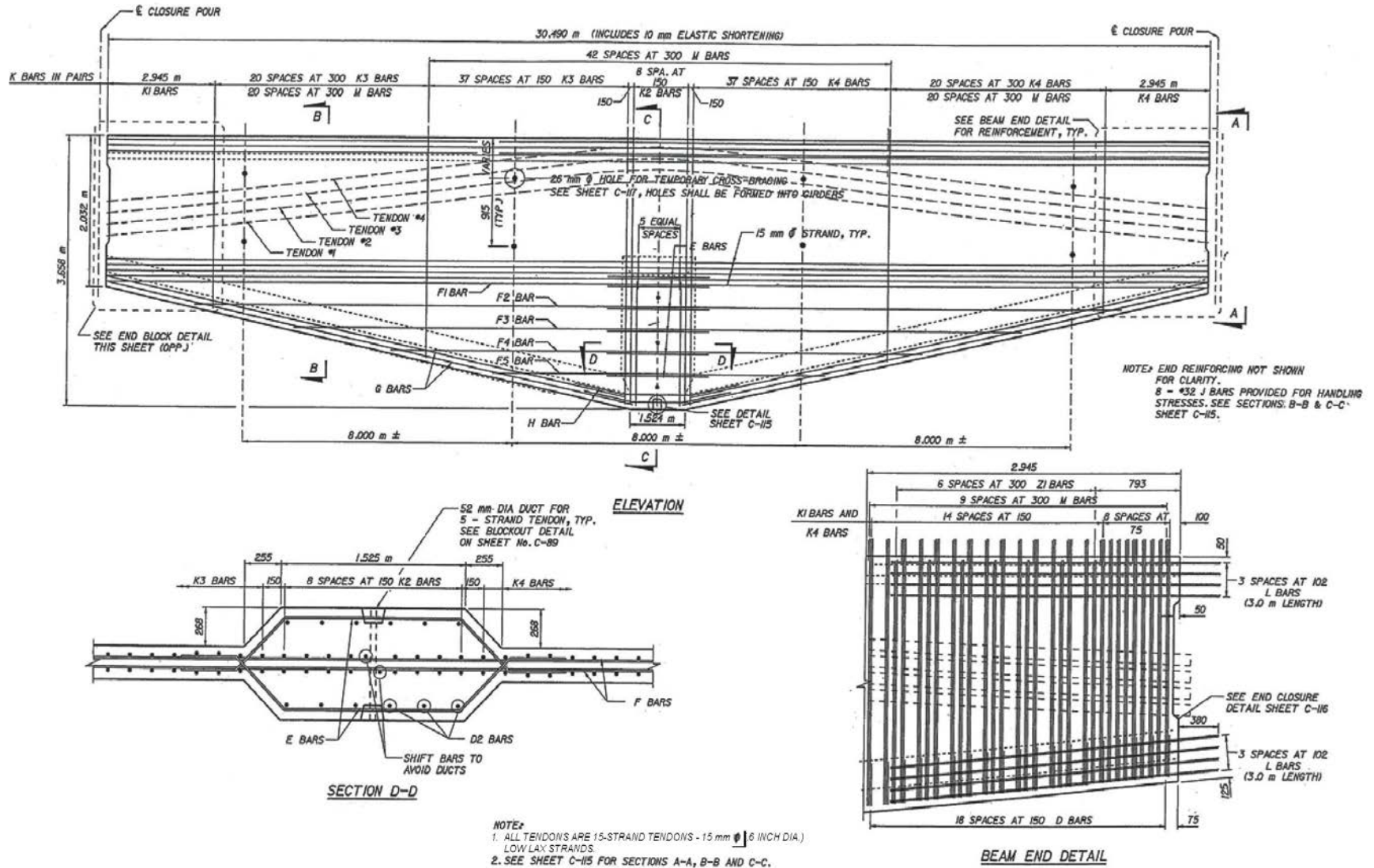


Figure 97. Illustration. Modified Florida bulb-T78 beam haunch segment.

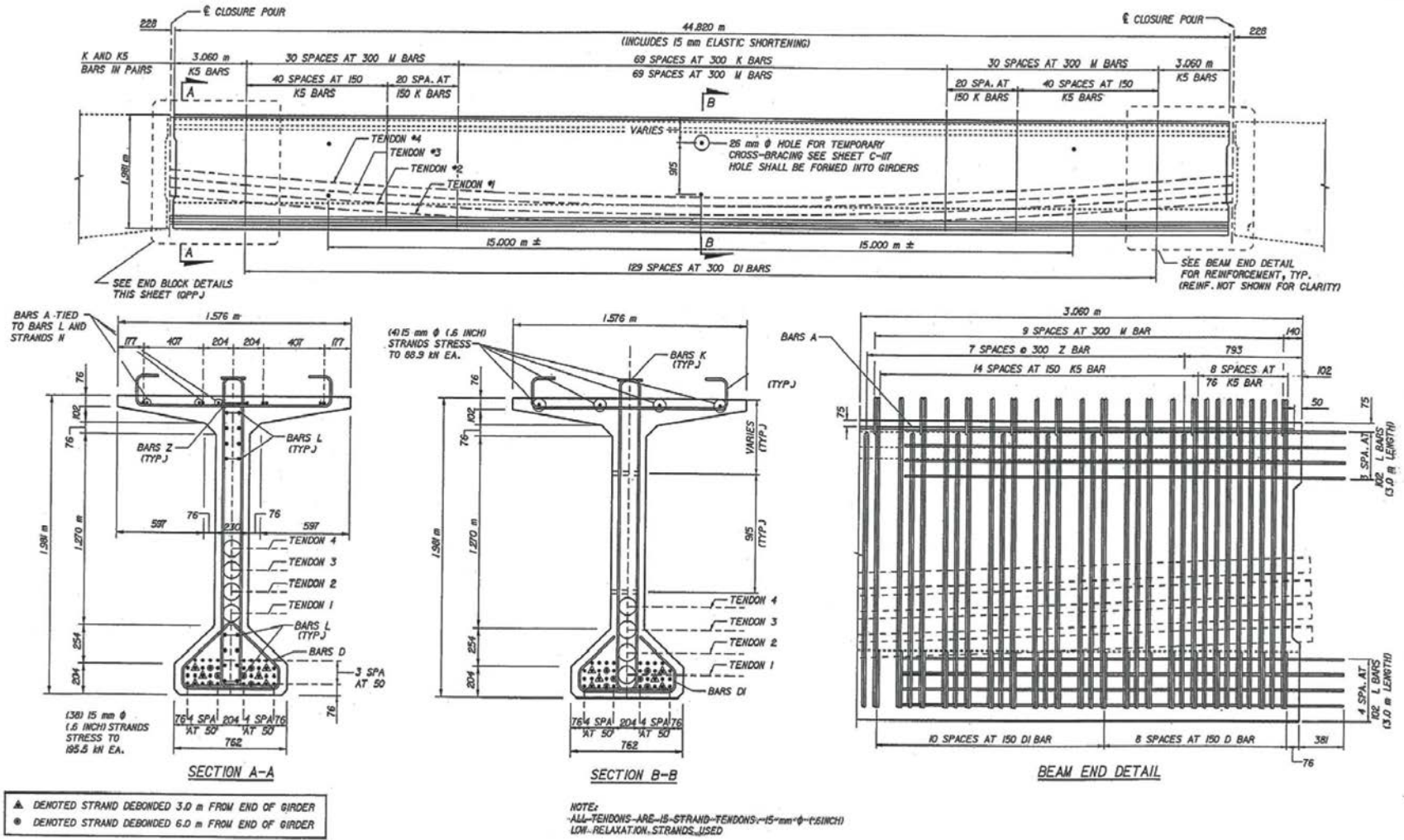


Figure 98. Illustration. Modified Florida bulb-T78 beam drop-in segment.

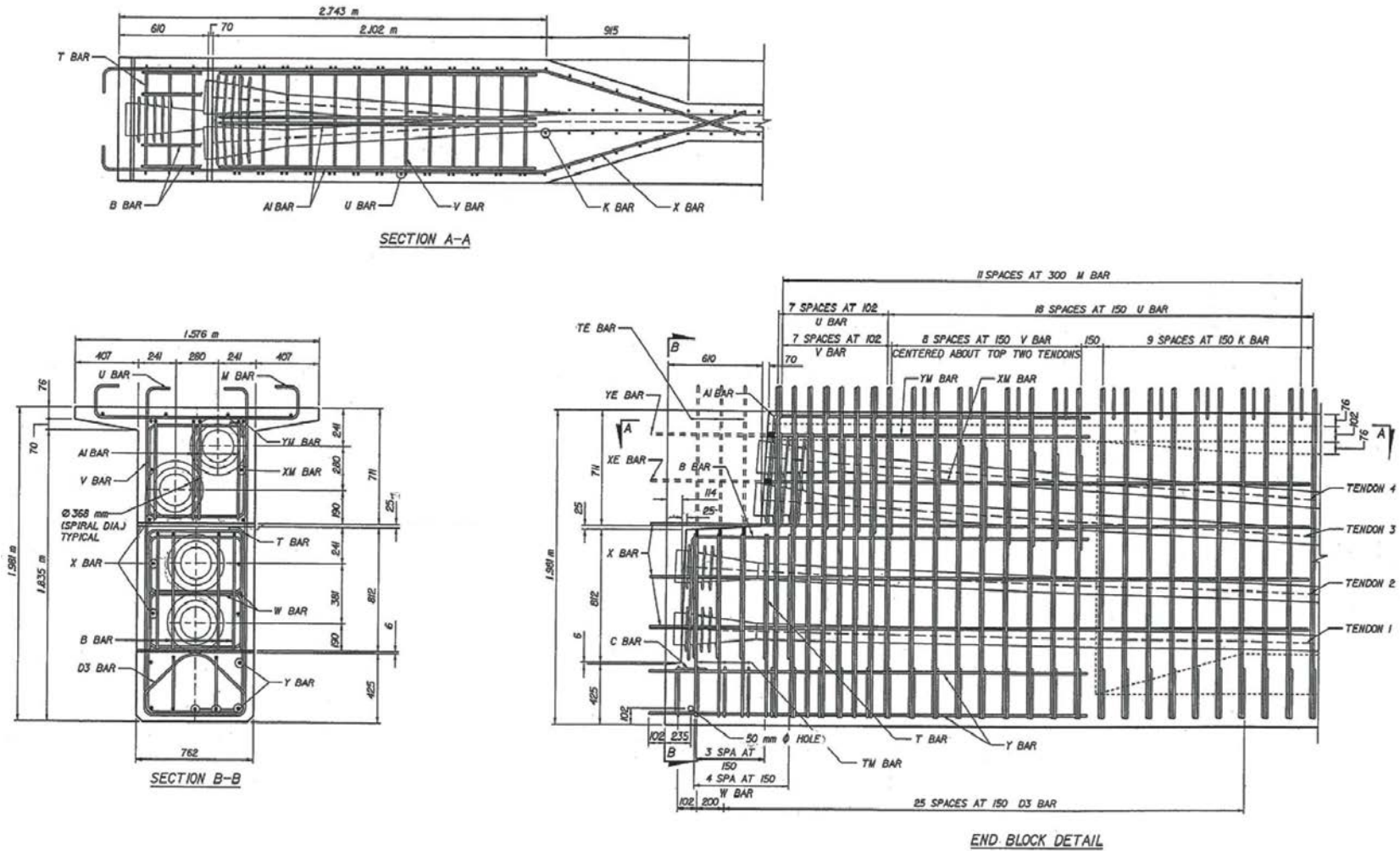


Figure 99. Illustration. Modified Florida bulb-T78 beam end block detail.

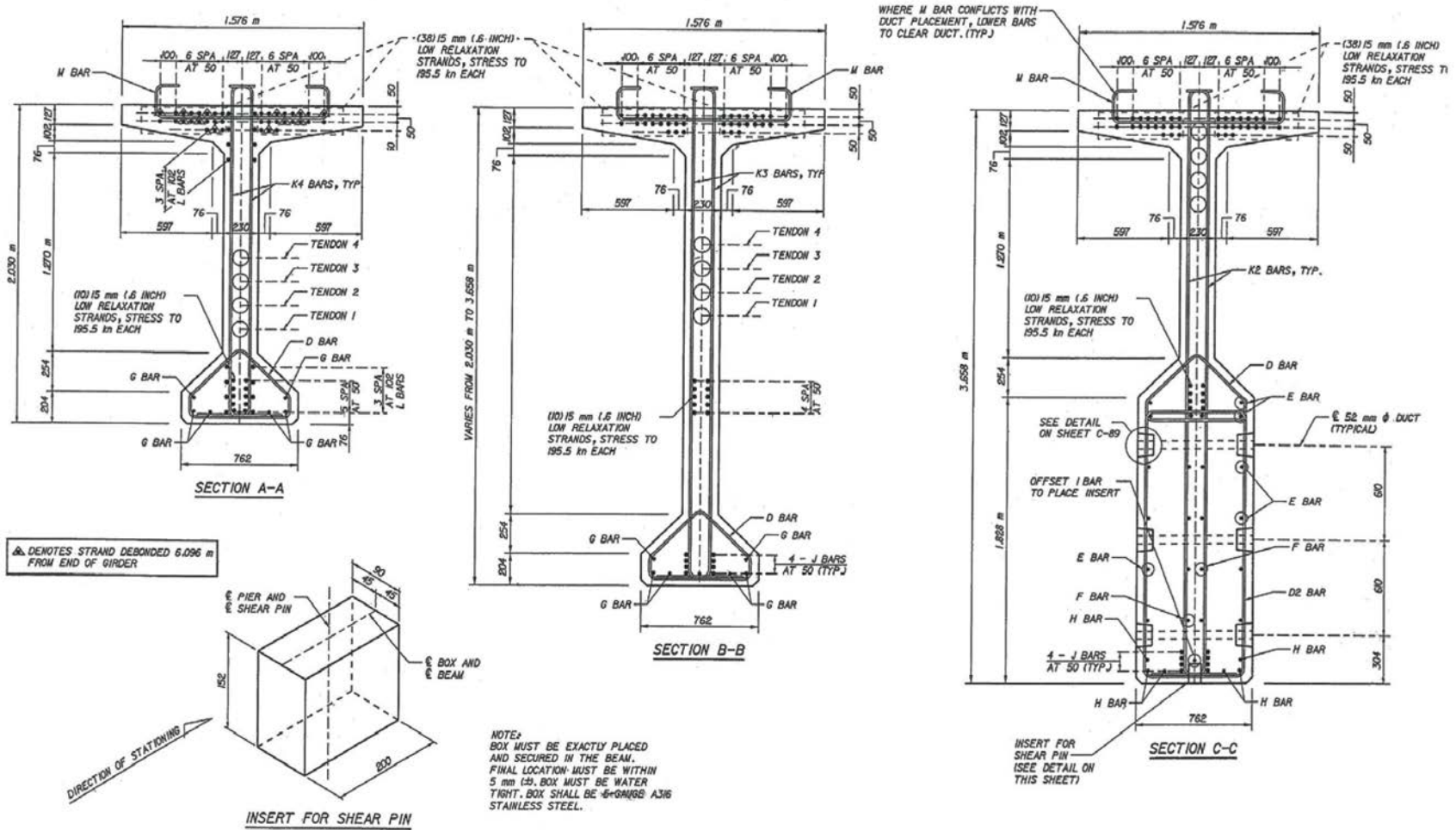


Figure 100. Illustration. Typical sections—haunch segment.





## REFERENCES

1. Merrill, B.D. (2011). *TxDOT PT/Grout Issues*, Presented to the American Segmental Bridge Institute Board of Directors, Washington, DC.
2. Corven Engineering, Inc. (2002). “New Directions for Florida Post-Tensioned Bridges,” *Post-Tensioning in Florida Bridges, I*, Florida Department of Transportation, Tallahassee, FL.
3. Pearson-Kirk, D., Collard-Jenkins, S.J., Theyro, T., and Chandra, V. (2004). *Improving the Durability of Segmental Bridges*, Parsons Brinckerhoff, New York City, NY.
4. Theyro, T. and Powers, R.G. (2011). *Post-Tensioned Bridges: Global Durability Issues and the Latest Developments for Future Improvement*, 56th Annual Kansas University Structural Engineering Conference, Lawrence, KS.
5. Post-Tensioning Institute. (2011). *Specifications for Grouting of Post-Tensioned Structures*, PTI M55.01-03, Farmington Hills, MI.
6. American Association of State Highway and Transportation Officials. (2010). *LRFD Bridge Construction Specifications*, 3d Edition, AASHTO, Washington, DC.
7. American Concrete Institute. (2008). *Guide to Durable Concrete*, ACI 201.2R-08, Farmington Hills, MI.
8. American Concrete Institute. (2010). *Protection of Metals in Concrete Against Corrosion*, ACI 222R-01, Farmington Hills, MI.
9. European Committee for Standardization. (2007). *Grout for Prestressing Tendons—Basic Requirements*, European Standard EN 447, Brussels, Belgium.
10. Monfore, G.E. and Verbeck, G.J. (1960). “Corrosion of Prestressed Wire in Concrete,” *Proceedings ACI Journal*, 32, 491.
11. Mohanned, T.U., Fukute, T., Yamaji, T., and Hamada, H. (2002). “Long-Term Durability of Concrete Made with Different Water Reducing Chemical Admixtures under Marine Environment,” *Concrete for Extreme Conditions*, 233.
12. Glass, G.K. and Reddy, B. (2002). *The Influence of the Steel Concrete Interface on the Risk of Chloride-Induced Corrosion Initiation*, 227, Proceedings of COST521 Workshop, Luxembourg.
13. Glass, G.K., Roberts, A.C., and Davison, N. (2004). *Achieving High Chloride Threshold Levels on Steel in Concrete*, Paper No. 04332, Presented at CORROSION/2004, NACE International, Houston, TX.

14. Ann, K.Y. and Buenfield, N.R. (2004). "The Influence of Calcium Nitrite on the Initiation of Chloride-Induced Corrosion of Steel in Concrete," *Proceedings International Conference on Concrete Under Severe Conditions: Environment and Loading*, 287, Seoul, South Korea.
15. Dubovoy, V.S., Gebler, S.H., and Klieger, P. (2002). "Cement Alkalinity Levels as it Affects Air-Void Stability, Freeze-Thaw Resistance, and Deicer Scaling Resistance in Concrete," *Research and Development Bulletin RD128*, Portland Cement Association, Skokie, IL.
16. Hartt, W.H. and Nam, J. (2008). "Effect of Cement Alkalinity on Corrosion Threshold and Time-to-Corrosion of Reinforcing Steel in Concrete," *Corrosion*, 64, 671.
17. Miller, R.L., Hartt, W.H., and Brown, R.P. (1976). "Stray Current and Galvanic Corrosion of Reinforcing Steel In Concrete," *Materials Performance*, 15(5), 20.
18. Godart, B. (2001). "Status of Durability of Post-Tensioned Tendons in France," *Durability of Post-Tensioned Tendons*, 25, Proceedings of FIB Workshop, Ghent, Belgium.
19. Fuzier, J.Ph. (2001). "Development of Grout and Grouting Techniques," *Durability of Post-Tensioned Tendons*, 173, Proceedings of FIB Workshop, Ghent, Belgium.
20. Chaussin, R. and Chabert, A. (2001). "Strategies for Improvement—Approach in France," *Durability of Post-Tensioned Tendons*, 235, Proceedings of FIB Workshop, Ghent, Belgium.
21. Bertolini, L. and Carsana, M. (2011). "High pH Corrosion of Prestressing Steel in Segregated Grout," *Modeling of Corroding Concrete Structures*, RILEM Series, 5, 147–158, Cedex, France.
22. Lau, K., Lasa, I., and Parades, M. (2011). *Corrosion Development of PT Tendons with Deficient Grout: Corrosion Failure in Ringling Causeway Bridge, Draft*, Florida Department of Transportation State Materials Office, Gainesville, FL.
23. Yu, H. and Hartt, W.H. (2007). "Effects of Reinforcement and Coarse Aggregates on Chloride Ingress into Concrete and Time-to-Corrosion: Part 1—Spatial Chloride Distribution and Implications," *Corrosion*, 63, 843.
24. ACI Committee 222. (2011). *Guide to Design and Construction Practices to Mitigate Corrosion of Reinforcement in Concrete Construction*, Report No. 222.3R-11, American Concrete Institute, Farmington Hills, MI.
25. Alonso, C., Andrade, C., Castellote, M., and Castro, P. (2007). "Chloride Threshold Values to Depassivate Reinforcing Bars Embedded in a Standardized OPC Mortar," *Cement and Concrete Research*, 30, 1047.
26. Sanches, A.N. and Sagüés, A.A. (2012). *Chloride Threshold Dependence on Potential in Reinforced Mortar*, Paper No. C2012-0001728, Presented at CORROSION/12, NACE International, Houston, TX.

27. Hartt, W.H., Powers, R.G., Presuel-Marino, F., Parades, M., Simmons, R., Hui, H., Himiob, R., and Virmani, Y.P. (2009). *Corrosion Resistant Alloys for Reinforced Concrete*, Report No. FHWA-HRT-09-020, Federal Highway Administration, Washington, DC.
28. Hartt, W.H. (2011). “Corrosion Initiation Projection for Reinforced Concrete Exposed to Chlorides: Part 2—Corrosion-Resistant Bars,” *Corrosion*, 67, 086002.
29. Page, C.L. and Vennesland, O. (1983). “Pore Solution Composition and Chloride Binding Capacity of Silica-Fume Cement Pastes,” *Matériaux et Constructions*, 16(1), 19.
30. Gouda, V.K. (1970). “Corrosion and Corrosion Inhibition of Reinforcing Steel Immersion in Alkaline Solutions,” *British Corrosion Journal*, 5, 198.
31. Schokker, A.J. and Musselman, E. (2008). *Varina-Enon Grout Evaluation*, Project No. BH-BR04(220), Pennsylvania State University Grouting Laboratory on Federal, State College, PA.
32. Pourbaix, M. (1994). *Atlas of Electrochemical Equilibria in Aqueous Solutions*, NACE International, Houston, TX.
33. Jones, D.A. (1996). *Principles and Prevention of Corrosion*, 2nd Ed., 212, Prentice Hall, Saddle River, NJ.
34. Grubb, J.A., Kelly, D.J., and Kelly, P.L. (2012). *Preliminary Field Sampling Plan for Chloride Content of Post Tensioning Grout*,” Draft Memorandum, Waltham, MA.
35. AASHTO T 260-97(2009). (2010). *Standard Method of Test for Sampling and Testing for Chloride Ion in Concrete and Concrete Raw Materials*, American Association of State Highway and Transportation Officials, Washington, DC.
36. ASTM E141-10. (2011). “Standard Practice for Acceptance of Evidence Based on the Results of Probability Sampling,” *Book of Standards Volume 14.02*, ASTM International, Conshohocken, PA.
37. ASTM C856-11. (2011). “Standard Practice for Petrographic Examination of Hardened Concrete,” *Book of Standards Volume 04.02*, ASTM International, Conshohocken, PA.
38. Roberge, P.R. (1999). *Handbook of Corrosion Engineering*, 377–383, McGraw-Hill, New York, NY.
39. Spiegel, M.R. (1992). *Theory and Problems of Probability and Statistics*, 113–114, McGraw-Hill, New York, NY.
40. ASTM C876-09. (2009). “Standard Test Method for Corrosion Potentials of Uncoated Reinforcing Steel in Concrete,” *Book of Standards Volume 03.02*, ASTM International, Conshohocken, PA.

41. ASTM G59-97(2009). (2009). "Standard Test Method for Conducting Potentiodynamic Polarization Resistance Measurements," *Book of Standards Volume 03.02*, ASTM International, Conshohocken, PA.
42. ASTM G102-89(2010). (2010). "Standard Practice for Calculation of Corrosion Rate and Related Information from Electrochemical Measurements," *Book of Standards Volume 03.02*, ASTM International, Conshohocken, PA.
43. Lee, S-K. (2012). *Literature Review of Chloride Threshold Values for Grouted Post-Tensioned Tendons*, Report No. FHWA-HRT-12-067, Federal Highway Administration, Washington, DC.



